

SY3634 – SY3634T

Bipolar Power Supply Heterogeneous System



User's Manual



All Rights Reserved
© CAEN ELS s.r.l.
Rev. 2 – August 2024

This product uses technology licensed by Elettra-Sincrotrone Trieste S.C.p.A.



This product is **CE** & compliant.
UK
CA

 **CAEN ELS s.r.l.**

Via Karl Ludwig Von Bruck 32- 34144 Trieste (TS)
Italy

Mail: info@caenels.com

Web: www.caenels.com



Table Of Contents

1. INTRODUCTION.....	10
1.1 SY3634 OVERVIEW	10
1.2 SYSTEM PARTS	11
1.3 EXTENDED VERSIONS – UP TO $\pm 40V$	13
2. SAFETY AND INSTALLATION	14
2.1 GENERAL SAFETY INFORMATION.....	14
2.2 INITIAL INSPECTION	14
2.3 INJURY PRECAUTIONS	14
2.3.1 <i>Caution</i>	15
2.4 GROUNDING.....	15
2.5 INPUT RATINGS	15
2.6 OUTPUT CONNECTORS	16
2.7 LIVE CIRCUITS	16
2.8 PART REPLACEMENT AND MODIFICATIONS	16
2.9 INSTALLATION INSTRUCTIONS	16
2.10 BULK CONTACTS PROTECTIVE COVER.....	18
3. SY3634 DESCRIPTION.....	20
3.1 A3636 AUXILIARY POWER SUPPLY	20
3.2 A36XXBS MODULE	22
3.2.1 <i>Internal Protections</i>	24
3.2.2 <i>External Interlocks</i>	27
3.2.2.1 <i>Interlocks Enabling/Disabling</i>	29
3.2.2.2 <i>Interlocks Activation States</i>	30
3.2.2.3 <i>Interlocks Intervention Time</i>	31
3.2.2.4 <i>Interlock Configuration Example</i>	31
3.3 EEPROM MEMORY MAPPING.....	33
3.3.1 <i>“Value” Section Cells</i>	36
3.4 STATUS REGISTER.....	37
3.5 BULK POWER SUPPLY	41
3.5.1 <i>Bulk Power Supply State Machine</i>	42
3.5.2 <i>A3631 Bulk Power Supply Cable</i>	43
3.6 SHK – SENTINEL HARDWARE KEY.....	44
4. LOCAL CONTROL	45
4.1 ENCODER	45
4.2 COLOUR DISPLAY	46
4.2.1 <i>Power-up Page</i>	46
4.2.2 <i>Home Page</i>	47
4.2.3 <i>Menu Page</i>	48
4.2.4 <i>ON/OFF Page</i>	49
4.2.5 <i>Set Current Page</i>	50
4.2.6 <i>Connectivity Page</i>	51
4.2.7 <i>MAC address page</i>	51
4.2.1 <i>IP address page</i>	52
4.2.2 <i>Global Stats Page</i>	53

5.	REMOTE CONTROL.....	54
5.1	PRELIMINARY INFORMATION	54
5.2	LIST OF COMMANDS.....	55
5.3	COMMANDS OVERVIEW	57
5.3.1	“BOFF” Command	58
5.3.2	“BON” Command.....	59
5.3.3	“FDB” Command.....	60
5.3.4	“HWRESET” Command.....	63
5.3.5	“MAC” Command	64
5.3.6	“MGC” Command.....	65
5.3.7	“MGLST” Command.....	66
5.3.8	“MOFF” Command.....	67
5.3.9	“MON” Command.....	68
5.3.10	“MRESET” Command.....	69
5.3.11	“MRF” Command	70
5.3.12	“MRG” Command	71
5.3.13	“MRH” Command	72
5.3.14	“MRI” Command.....	73
5.3.15	“MRID” Command.....	74
5.3.16	“MRM” Command.....	75
5.3.17	“MRP” Command	76
5.3.18	“MRT” Command.....	77
5.3.19	“MRTS” Command.....	78
5.3.20	“MRV” Command	79
5.3.21	“MRW” Command.....	80
5.3.22	“MSP” Command.....	81
5.3.23	“MSR” Command.....	82
5.3.24	“MST” Command	83
5.3.25	“MUP” Command	84
5.3.26	“PTP” Command.....	85
5.3.27	“SIP” Command.....	86
5.3.28	“VER” Command	87
5.3.29	“MWAVE” Command.....	88
5.3.30	“MWAVEP” Command	89
5.3.31	“MWAVER” Command	90
5.3.32	“MWAVESTART” Command	91
5.3.33	“MWAVESTOP” Command	92
5.3.34	“MWF” Command.....	93
5.3.35	“MWG” Command	94
5.3.36	“MWH” Command	95
5.3.37	“MWI” Command.....	96
5.3.38	“PASSWORD” Command	97
5.4	IP ADDRESS CONFIGURATION	98
5.4.1	IP Address configuration - SIP command	99
5.4.2	IP Address configuration - TELNET connection	100
5.4.3	IP Address configuration - DeviceInstaller®	102
6.	TECHNICAL SPECIFICATIONS	104
	ANNEX A - OUTPUT CONNECTORS	106

Document Revision	Date	Comment
0.0	September 6 th 2011	Draft
1.0	February 22 nd 2012	First Release: Safety and Installation section added
1.1	February 27 th 2012	IP address configuration FDB command Some figures added Output connector pinout
1.2	April 25 th 2012	Minor corrections and Bulk State Machine added
1.3	April 19 th 2013	Minor corrections and bulk contacts protection added
1.4	February 20 th 2014	SY3634T version and Extended models added
1.6	November 3 rd 2014	Manual graphics changed
1.7	November 22 nd 2022	Added UKCA compliance logo
2	August 8 th 2024	Updated address and revision numbering

Safety information - Warnings

CAENels will repair or replace any product within the guarantee period if the Guarantor declares that the product is defective due to workmanship or materials and has not been caused by mishandling, negligence on behalf of the User, accident or any abnormal conditions or operations.

Please read carefully the manual before operating any part of the instrument



High voltage inside, do NOT open the boxes

CAENels d.o.o. declines all responsibility for damages or injuries caused by an improper use of the Modules due to negligence on behalf of the User. It is strongly recommended to read thoroughly this User's Manual before any kind of operation.

CAENels d.o.o. reserves the right to change partially or entirely the contents of this Manual at any time and without giving any notice.

Disposal of the Product

The product must never be dumped in the Municipal Waste. Please check your local regulations for disposal of electronics products.



Read over the instruction manual carefully before using the instrument.
The following precautions should be strictly observed before using the SY3634:

WARNING

- Do not use this product in any manner not specified by the manufacturer. The protective features of this product may be impaired if it is used in a manner not specified in this manual.
- Do not use the device if it is damaged. Before you use the device, inspect the instrument for possible cracks or breaks before each use.
- Do not operate the device around explosives gas, vapor or dust.
- Always use the device with the cables provided.
- Turn off the device before establishing any connection.
- Do not operate the device with the cover removed or loosened.
- Do not install substitute parts or perform any unauthorized modification to the product.
- Return the product to the manufacturer for service and repair to ensure that safety features are maintained

CAUTION

- This instrument is designed for indoor use and in area with low condensation.

The following table shows the general environmental requirements for a correct operation of the instrument:

Environmental Conditions	Requirements
Operating Temperature	5°C to 45°C
Operating Humidity	30% to 85% RH (non-condensing)
Storage Temperature	-10°C to 60°C
Storage Humidity	5% to 90% RH (non-condensing)



1. Introduction

This chapter describes the general characteristics and main features of the SY3634 heterogeneous bipolar power supply system.

1.1 SY3634 Overview

High efficiency, high stability, easiness of configuration and maintenance are the key features of the SY3634 power supply (PS) system.

The SY3634 houses up to 4 independent current-controlled digital bipolar power supply modules of the A36xxBS series, rated at:

- $\pm 5\text{A}$ @ $\pm 20\text{V}$ (A3605BS);
- $\pm 10\text{A}$ @ $\pm 20\text{V}$ (A3610BS);
- $\pm 12\text{A}$ @ $\pm 20\text{V}$ (A3612BS);
- $\pm 20\text{A}$ @ $\pm 20\text{V}$ (A3620BS);
- $\pm 30\text{A}$ @ $\pm 20\text{V}$ (A3630BS);

A complete 4-channel system fits in a single 19-inch 3U standard crate (excluding the external bulk power supply).

Each module implements a completely digital control loop with a propriety Pulse Width Modulation (PWM) generation technique that makes the system extremely versatile and easy to “tune” to any load condition.

A36xxBS modules are internally composed by a Control Board (CB) and a Power Board (PB) that are mechanically connected: communication between boards is performed by digital signals that avoid possible analog signal corruption and undesired noise pick-up.

The control board houses a dedicated digital signal processor (DSP) that performs the current control loop and a FPGA that supervises all process as communication, diagnostics and interlock handling.

Remote communication is guaranteed by means of an Ethernet 10/100 auto-sensing socket accessible from each module front panel; the power supply can also be locally monitored and controlled via an encoder and a graphic color display featuring user-friendly menus.

A different version of the crate – **SY3634T** – is provided with terminal output connections and with the auxiliary AC mains ON/OFF switch on the rear side.

1.2 System Parts

An entire operational SY3634 system (**Figure 1**) is composed by two 19-inch crate, for a total of 4U – 3U for the system and 1U for the bulk – and four different main parts:

- the SY3634 crate that houses up to four independent A36xxBS DC/DC modules and one auxiliary power converter in its left first spot – i.e. A3636;
- the bulk power supply that provides the DC-Link, up to 24V@120A, to the connected SY3634 crate;
- the Sentinel Hardware Key (SHK) – i.e. A3632 – that adds some control and monitoring functionalities to the bulk power supply (faulty module warning and DC-Link output voltage adjustment).

Other elements that complete the SY3634 system are:

- the bulk cable – i.e. A3631 – that connects the bulk outputs to the SY3634 crate;
- the channel output and interlock connector – i.e. A3633 – a connector set for channel output and external interlock signals.



Figure 1: front view of a complete SY3634 system

All the elements cited above are independent, which means that any of them can be replaced without the need of changing the other ones.

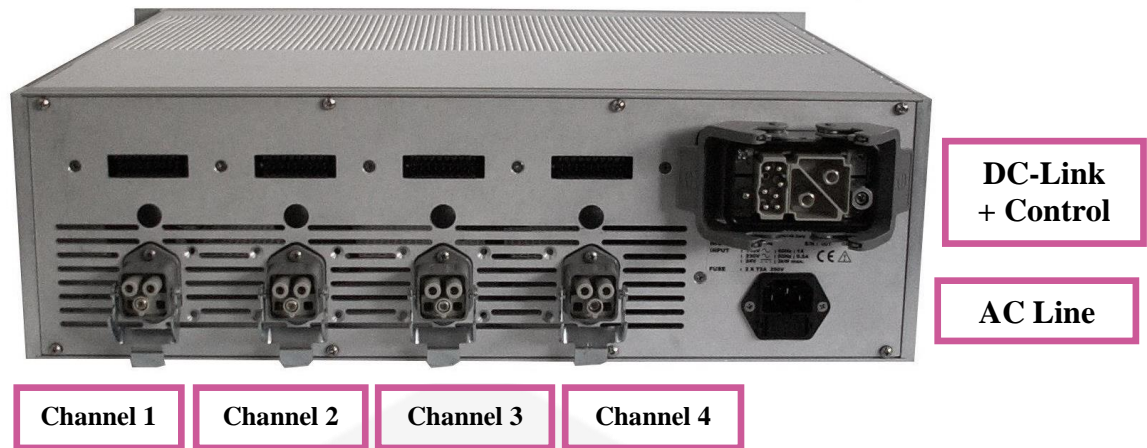

Figure 2: rear view of the SY3634 system

Channel interlock and current output connectors, AC line input and DC-Link power and control signals are all available on the SY3634 rear panel, as shown in **Figure 2**.

The SY3634 system comes also on a different version – i.e. **SY3634T** – that differs by the standard one by the output connectors and the AC mains input socket. The rear view of the SY3634T is shown in **Figure 3**.

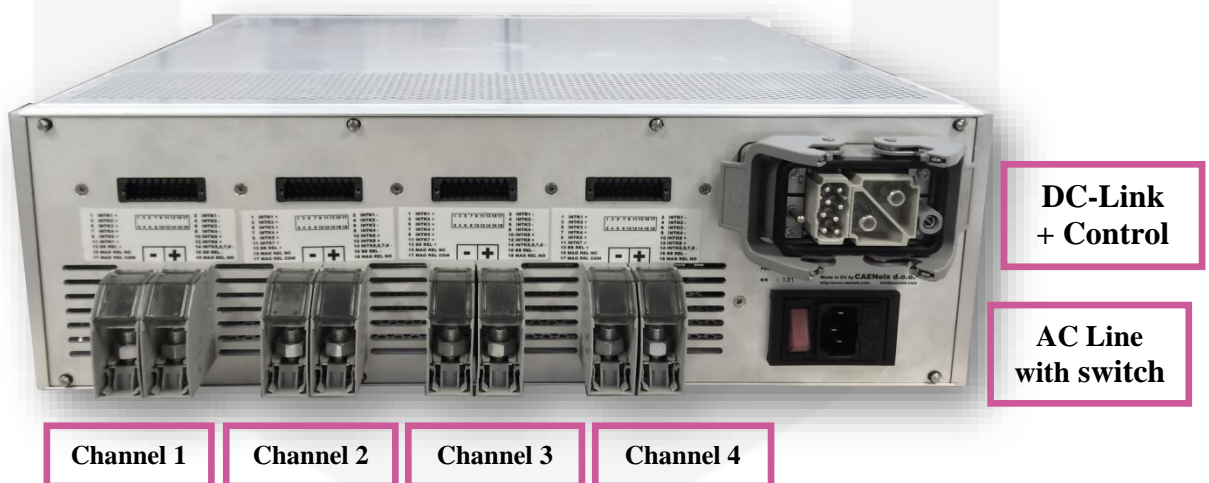

Figure 3: rear view of the SY3634T system crate

The output connections are made by terminal screw connectors (with M8 screws) and the AC mains input plug has an additional ON/OFF switch respect to the SY3634 standard model.

1.3 Extended Versions – up to $\pm 40V$

Some of the A36xxBS modules can be configured in order to reach a maximum output voltage of $\pm 40V$. The modules that can be configured in order to reach this voltage are the following ones:

- A3605BS – rated at $\pm 5A$;
- A3610BS – rated at $\pm 10A$;
- A3612BS – rated at $\pm 12A$.

The limitation of this customization to only these three A36xxBS models is given by the power rating of the modules themselves.

2. Safety and Installation

Please read carefully this general safety and installation information before using the product.

2.1 General Safety Information

This section contains the fundamental safety rules for the installation and operation of the system. Read thoroughly this section before starting any procedure of installation or operation of the product.

Safety Terms and Symbols on the Product

These terms may appear on the product:

- **DANGER** indicates an injury hazard immediately accessible as you read the marking;
- **WARNING** indicates an injury hazard not immediately accessible as you read the marking;
- **CAUTION** indicates a hazard to property including the product.

2.2 Initial Inspection

Prior to shipment this system was inspected and found free of mechanical or electrical defects. Upon unpacking of the system, inspect for any damage, which may have occurred in transit. The inspection should confirm that there is no exterior damage to the system such as broken knobs or connectors and that the front panels are not scratched or cracked.

Keep all packing material until the inspection has been completed. If damage is detected, file a claim with carrier immediately and notify CAENels d.o.o. service personnel.

2.3 Injury Precautions

This section contains the fundamental safety rules for the installation and operation of the system in order to avoid injuries.

2.3.1 Caution

The following safety precautions must be observed during all phases of operation, service and repair of this equipment. Failure to comply with the safety precautions or warnings in this document violates safety standards of design, manufacture and intended use of this equipment and may impair the built-in protections within.

CAENels d.o.o. shall not be liable for user's failure to comply with these requirements.

To avoid electrical shock or fire hazard, do not apply a voltage to a load that is outside the range specified for that load.

Do Not Operate Without Covers.

To avoid electric shock or fire hazard, do not operate this product with covers or panels removed.

Do Not Operate in Wet/Damp Conditions.

To avoid electrical shock, do not operate this product in wet or damp conditions.

Do Not Operate in an Explosive Atmosphere.

To avoid injury or fire hazard, do not operate this product in an explosive atmosphere.

Do Not Operate With Suspected Failures.

If you suspect there is damage to this product, have it inspected by qualified service personnel.

2.4 Grounding

To minimize shock hazard, the SY3634 power supply system must be connected to an electrical ground. The ground terminal is present on the mains sockets on the back side of the crate.

2.5 Input Ratings

Do not use AC supply which exceeds the input voltage and frequency rating of this instrument. For input voltage and frequency rating of the module see Chapter 6.

For safety reasons, the mains supply voltage fluctuations should not exceed above voltage range.

2.6 Output Connectors

Do not plug or unplug output connectors when power converters are on and the power units are regulating current on the electrical load.

2.7 Live Circuits

Operating personnel must not remove the 19" crates covers. No internal adjustment or component replacement is allowed to non-CAENs d.o.o. personnel. Never replace components with power cables connected.

In order to avoid injuries, always disconnect power plugs, discharge circuits and remove external voltage source before touching components (wait 5 minutes at least).

2.8 Part Replacement and Modifications

Always disconnect power plugs, discharge circuits and remove external voltage source prior to fuse replacement (wait 5 minutes at least).

Other parts substitutions and modifications are allowed by authorized CAENs d.o.o. service personnel only.

2.9 Installation Instructions

Follow these instructions in order to correctly install the SY3634 power supply system.

Install the 3U SY3634 system crate in a rack with its corresponding 1U bulk power supply crate (A3640 – SY3634 Bulk Power Supply 40A) on its bottom.

Now connect both power connector (with screw-dedicated terminals) and control connector – i.e. DB25 – on one end of the A3631 - Bulk PS Power Cable, using the optional module A3632 - SHK (Sentinel Hardware Key) if purchased.

The other end of the A3631 must be connected to the SY3634 system crate, as shown in the following figure.

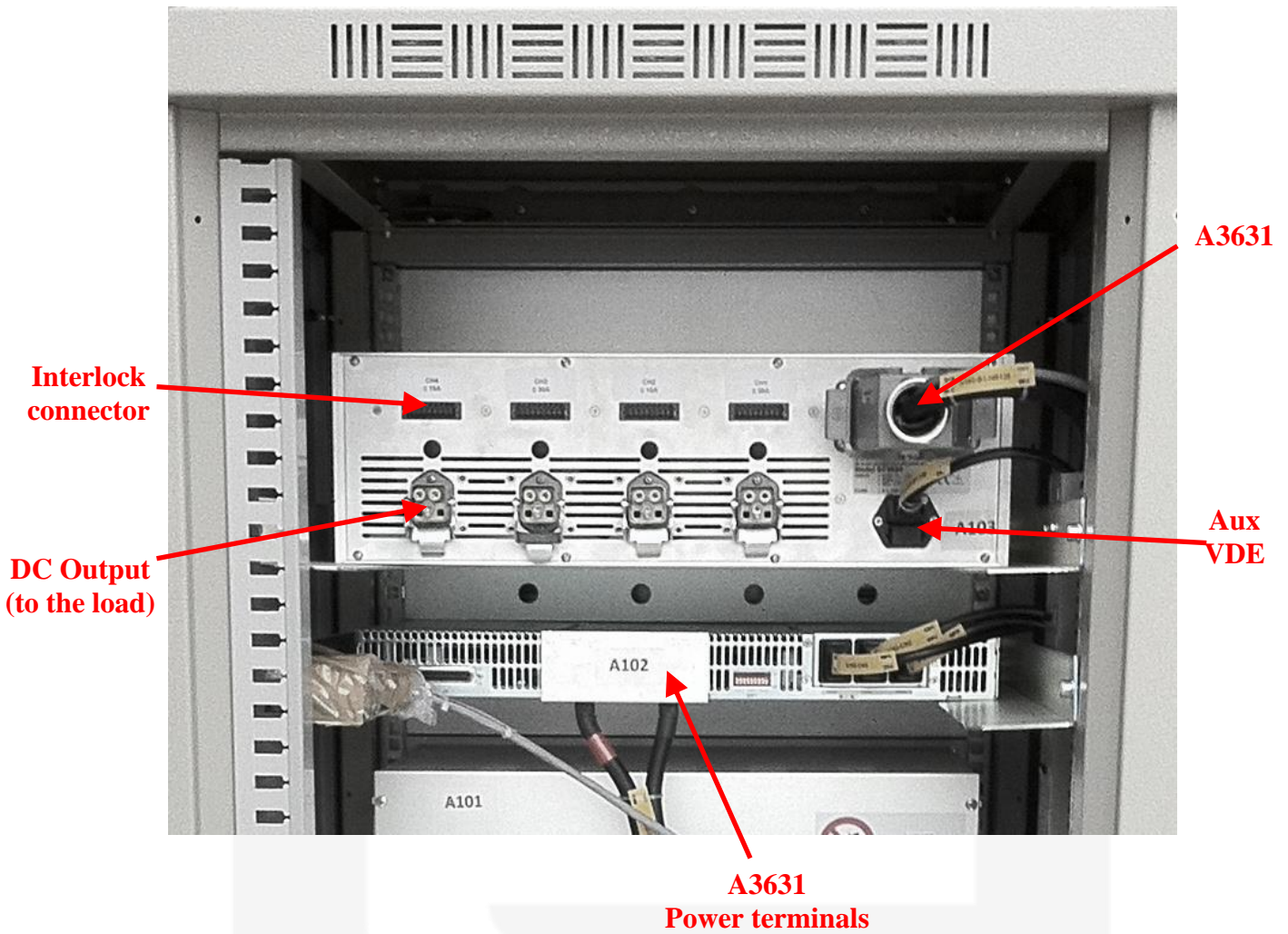

Connect one VDE flexible cable to each bulk unit module inserted in the relevant 1U chassis (indicated in the figure).



Please note that the position of the power plugs on the rear side of the bulk crate is “geographic” – i.e. the first socket on the right corresponds to first module on the right, center socket to center module and last socket on the left to last module on the left, whatever is present).

Now also connect the VDE power plug on the rear panel of the SY3634 system crate: this VDE directly supplies the A3636 – Auxiliary Power supply of the crate.

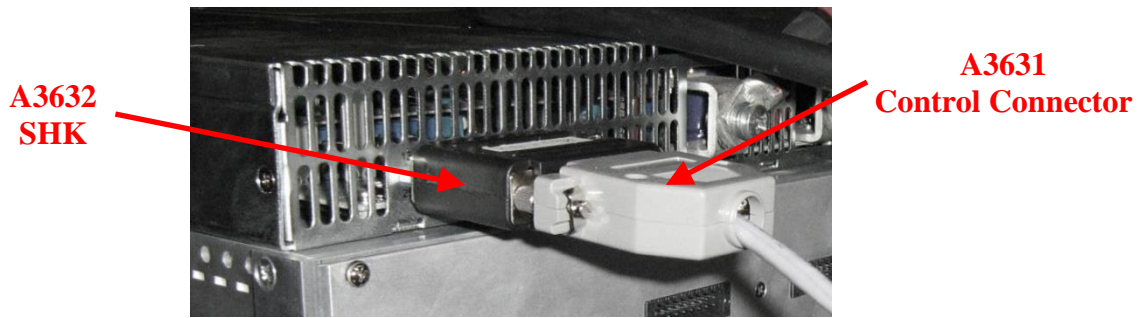

If the A3632 – SHK (Sentinel Hardware Key) is available, please connect it between the A3631 – Bulk PS cable DB25 connector end and the DB-25 receptacle on the bulk power supply 1U unit.

Connect as many A3633 - CH & Interlock Connector Kit in every relevant socket (wire towards your loads).

The DC output *Harting Han-40A* connectors (see **Annex A - Output Connectors** for further information on how to connect them) are to be directly connected to the load – e.g. magnet.

The interlock connectors are respectively referred to every single channel and can be connected to the desired interlock sources directly involved in that particular channel operation. For further interlock information and pinout, please refer to section 3.2.2.

2.10 Bulk Contacts Protective Cover

In order to fix the cover to the bulk crate mechanics, some “mounting supports” have been made and can be installed as shown in the following images:



These “mounting pins” have to be inserted inside the crate rear panel cooling holes as indicated:



Two M3 screws can be used in order to guarantee a better fixing of the cover: these screws would avoid the cover to unfasten from the 1U chassis in case some of some heavy objects dropping from the top.



3. SY3634 Description

A description of the SY3634 and the A36xxBs module is herein presented with some in-depth explanations on the basic power supply functionalities.

3.1 A3636 Auxiliary Power Supply

The SY3634 heterogeneous bipolar power supply system contains a unit – i.e. A3636 – that should be installed in the first left slot of the system crate and it is used to power the control electronics and the cooling fans of all the A36xxBS modules installed in the same crate with 12V. This unit is shown in **Figure 4**:



Figure 4: A3636 auxiliary power supply

Other components are installed on the same PCB carrier for the control mode selection (REMOTE/LOCAL) and for the connection of the DC-Link external unit to earth potential with a ground fuse.

The control mode selection – i.e. LOCAL or REMOTE – is placed on the front panel, as can be seen in **Figure 5**:



Figure 5: A3636 front panel

Three LEDs are also placed on the front panel of this auxiliary module and have to be interpreted as follows:

- **ON LED:** the green light indicates that the A3636 auxiliary power converter is correctly working and the 12V for the control electronic is present on the backplane;
- **EF LED:** the red light indicates that the earth fuse (rated at 1AT) is blown-up, probably consequently to an earth fault, and needs to be replaced;
- **REM LED:** the green light indicates that the entire SY3634 system is placed in a REMOTE mode of operation, so that setting commands for all the A36xxBS modules can only be received via the Ethernet remote connection. Readings are anyway still visible from the local displays. The REM LED

indicator in off state indicates that the system is set in LOCAL mode of operation.

Two 12V fans, placed on the front panel, are used to cool the A3636 auxiliary power supply and the left-side of the A36xxBS module installed right next to the auxiliary power converter on the SY3634 system crate.

3.2 A36xxBS Module

The A36xxBS module series is commercially available in five different models, rated at different DC output currents:

- **A3605BS**: rated at $\pm 5A$ output current;
- **A3610BS**: rated at $\pm 10A$ output current;
- **A3612BS**: rated at $\pm 12A$ output current;
- **A3620BS**: rated at $\pm 20A$ output current;
- **A3630BS**: rated at $\pm 30A$ output current;



Figure 6: A36xxBS module front view

All these modules are bipolar current-controlled power supplies and are especially developed to work in conjunction with a 12V or a 24V (standard) external bulk power supply unit. **The X-tended version of the modules up to 12A is available on request and allowing a maximum output voltage of 40V.**

Each A36xxBS module front panel has two holes for the air inlet, necessary for the front-to-rear fan cooling system, a standard RJ-45 Ethernet socket, a local display, a rotary encoder with push-button capability, a small hole for accessing the local unit reset and six LEDs, as can be seen in **Figure 7** (A3630BS module front label is taken as an example):

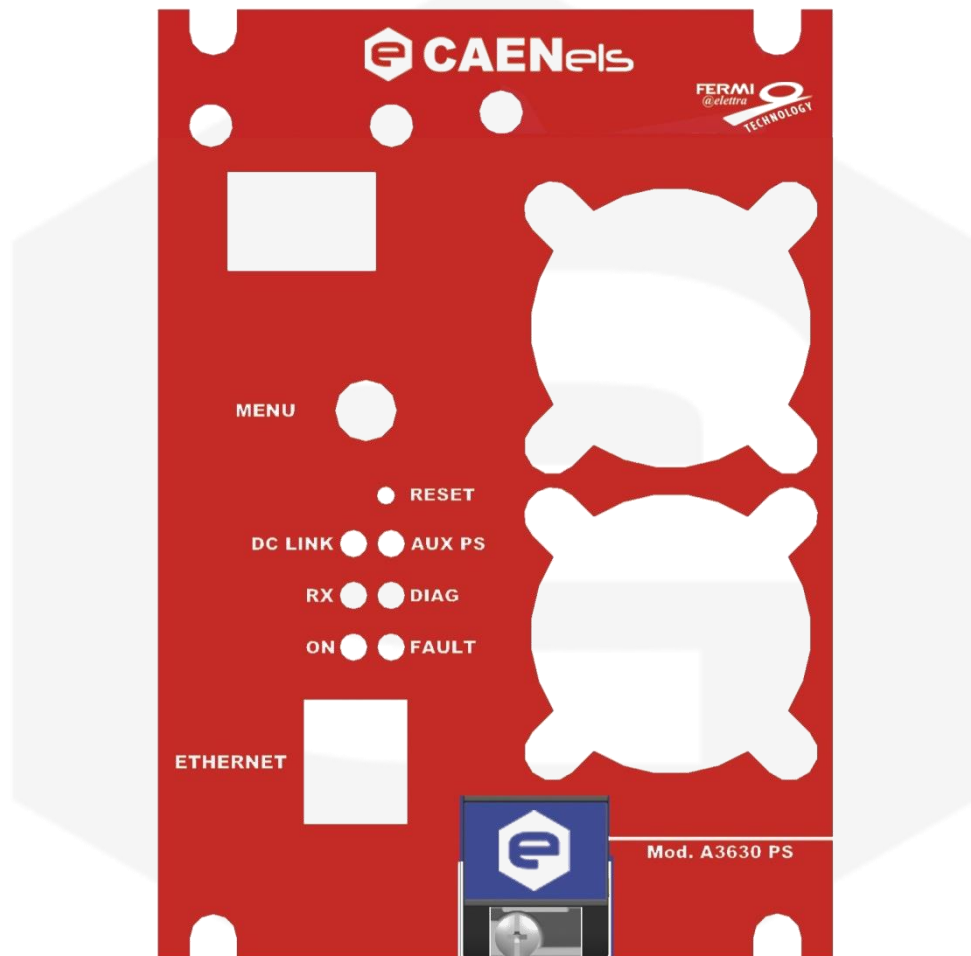

Figure 7: A3630BS front panel

The LEDs are indicators of the power supply status and have to be interpreted as follows:

- **DC LINK LED:** the green light indicates that the bulk power supply voltage is correctly fed to the A36xxBS module;
- **AUX PS LED:** the green light indicates that the control electronic section voltage – i.e. 3.3V, directly obtained from the 12V of the A3636 auxiliary power supply – is correctly working;

- **RX LED:** the blue light toggles at every “termination character” reception – i.e. *carriage return* ‘\r’ – and it is a kind of communication heartbeat indicator;
- **DIAG LED:** the white light it is modulated by an internal PWM counter that is internally serviced and reset by the control electronics at every diagnostic routine execution. If this LED is not modulating its light, the internal diagnostics it is not correctly executed by the module.
- **ON LED:** the blue light indicates that the A36xxBS module is in ON state and it is correctly regulating output current;
- **FAULT LED:** the red light indicates that the A36xxBS has experienced a generic fault that can be either an internal protection trip or an external interlock intervention. This light does not turn off after a fault until a local or a remote module reset has been performed.

It is important to notice that the blue ON light and the red FAULT light cannot be on at the same moment because the module cannot correctly regulate output current if a fault is experienced and the output stage of the power supply is disabled.

3.2.1 Internal Protections

Each A36xxBS module is equipped with multiple internal protections (hardware and software) to avoid unwanted behaviors or eventual damages to the unit and also to let users run the power supply safely.

All hardware protections are installed on the A36xxBS Power Board and are here listed:

- OVC (Over-Current protection);
- CB (CrowBar protection);
- DC-Link Fuses;
- over-voltage clamping;
- cross-conduction protection

Several software protections, some of them redundant, are also implemented and here listed:

- DC-Link under-voltage protection;
- OVC (Over-Current protection);
- CB (Crowbar protection);
- MOSFETs over-temperature;
- shunt resistor over-temperature;
- earth leakage detector.

Protection redundancy – i.e. hardware and software – was especially implemented in order to guarantee a double level of reliability for the specified type of power supplies.

An overview of all available protections, as well as a brief description of their behavior, is presented in the following sections.

3.2.1.2 OVC – OVerCurrent

The OVC check (hardware + software) is performed on each module DC-Link input current and protects from short-circuit conditions that could arise in the output stage section.

This protection is obtained from a Schmitt-triggered signal fed by an opportunely conditioned Hall-sensor that directly disables the output stage bridge driver.

The signal is also fed to the FPGA that disables the output power stage of the A36xxBS in case an over-current condition arises.

The acting of the over-current protection generates a FAULT condition on the power supply status register and should be reset before re-enabling the output.

3.2.1.3 CB – CrowBar

The A36xxBS module protection against output over-voltage conditions is guaranteed by a crowbar protection circuit that, as in the case of the over-current protection one, has a double level of reliability – i.e. both hardware and software.

This protection is hardware-activated when the output voltage crosses the threshold of:

$$V_{CB_threshold} = 28.5V$$

that is usually caused by a large $di(t)/dt$ value on a large reactive load.

The crowbar circuit also guarantees dissipation of the residual energy stored in the load when turning off the power supply output stage from a high current value on a high inductive load (i.e. 30A on a 20mH magnet).

This protection also activates a galvanically-isolated logic signal that generates a software interrupt on the on-module FPGA: when this signal is activated, the FPGA sets a flag in the status register that needs to be reset before re-enabling the channel output again.

3.2.1.4 DC-Link Fuses

The module DC-Link input current is already monitored by the hardware and software overcurrent protections but the power module has an additional feature that is given by fuses, thus generating a third level of reliability.

The rated fusing current is 30A, obtained from the parallel connection of three 10A surface-mounted fuses.

The DC-Link fuses blowing is a hardware protection themselves and their time of intervention is higher than the one presented by the OVC circuit so that they act – i.e. blow up – only in case of a fault of both the overcurrent protecting systems.

3.2.1.5 Over-Voltage Clamping

The over-voltage behavior obtained from the energy stored by a large inductive load, before the eventual crowbar protection intervention, is heavily limited by a parallel array of TVS(Transient Voltage Suppressors) operating at a voltage:

$$V_{TVS} = 26V$$

3.2.1.6 Cross-Conduction Inhibition

The A36xxBS modules are protected from cross-conduction, on both legs of the H-bridge, by a discrete logic network acting directly on the PWM (Pulse Width Modulation) signals.

Cross-conduction conditions are already discarded by the presence of an opportunely tuned dead-time interval between driving signals but this protection gives an extra-level of reliability to this power supply critical stage.

3.2.1.7 DC-Link Under-Voltage

The DC-Link under-voltage protection operates whenever the DC-Link voltage, monitored by a 16-bit ADC on the power supply FPGA, drops below a user-definable threshold.

This situation can be caused either by a generic DC-Link AC/DC failure – e.g. bulk power supply fault or disconnection – or by blown DC-Link fuses that do not allow current to flow into the board.

The intervention of this protection disables the output stage driving signals; as in the other cases, a FAULT condition is generated and a “DC-Undervoltage” flag is set in the A36xxBS power supply status register. This status register must be reset before turning the output ON again.

Note: this value can be configured writing EEPROM “value” cell 23 (see ‘MWF Command’ Section for more information).

3.2.1.8 MOSFETs Over-Temperature

The MOSFETs composing the power supply output stage are all connected to a common heatsink that is monitored by a high-gain temperature sensor.

The FPGA disables the H-Bridge when the temperature rises above a user-defined threshold value, stored in EEPROM cell #20 (factory default values are highly recommended), and sets a “MOSFET over-temperature” flag in the status register, thus generating a FAULT condition that, as in the other cases, needs to be reset before enabling the output again.

Note: this value can be configured writing EEPROM “value” cell 20 (see ‘MWF Command’ Section for more information).

3.2.1.9 Shunt Resistor Over-Temperature

The precision shunt resistor used for current sensing is connected to a different heatsink (respect to the MOSFETs) but its temperature is directly monitored on its case by another high-gain sensor connected to a 16-bit ADC.

The FPGA disables the output stage – i.e. H-bridge – when this temperature rises above a user-defined threshold value, stored in EEPROM cell #21 (factory default values are highly recommended), and sets a “Shunt over-temperature” flag in the status register, thus generating a FAULT condition that needs to be reset before enabling the output again.

Note: this value can be configured writing EEPROM “value” cell 21 (see ‘MWF Command’ Section for more information).

3.2.1.10 Earth Leakage Current Detector

A flux-gate DCCT with a peak detector is capable to detect Common Mode Direct Current (CMDC) that flows through the output terminals. A common mode current may be present when the load or cabling to the load has a weak isolation to ground.

The CMDC is measured by a 16-bit ADC so that the threshold that trips the earth current limit fault can be configured by software: EEPROM cell #31 stores this value.

The on-board DCCT has a unipolar output – e.g. only the absolute value of the current is reported – so that the limit value to configure must represent the absolute maximum leakage current. This limit value should be greater than 50mA since the measuring accuracy is about 50mA.

Note: this value can be configured writing EEPROM “value” cell 31 (see ‘MWF Command’ Section for more information).

3.2.2 External Interlocks

Each A36xxBS module has different configurable *dry-contact* input interlocks and some output status signals that are directly available on one the SY3634 rear panel

interlock connector. Each A36xxBS has its own interlock connector. The pin index is summarized in **Table 1**:

Pin Number	Function
1	Interlock 1
2	Interlock 1 return
3	Interlock 2
4	Interlock 2 return
5	Interlock 3
6	Interlock 3 return
7	Interlock 4
8	Interlock 4 return
9	Interlock 5
10	Interlock 6
11	Interlock 7
12	Interlock 8
13	Solid state Relay
14	Interlock 5,6,7, 8 return
15	Magnetic Relay NC-TAP
16	Solid state Relay return
17	Magnetic Relay C-TAP
18	Magnetic Relay NO-TAP

Table 1: Rear Interlock Connector Pinout

The four interlock connectors – one for each possible A36xxBS module installed in a SY3634 system – are *Weidmuller* 18-pin male connectors. The corresponding pinout is shown in **Figure 8**.

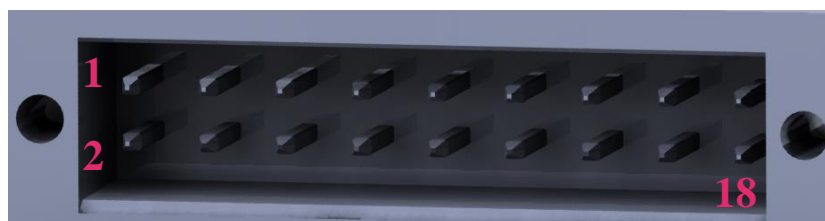

Figure 8: Interlock connector on SY3634 rear panel

Please notice that all interlock pins are galvanically isolated from ground and outputs terminals, nevertheless the absolute maximum voltage, referred to ground, that pins can sustain is 48V.

Note: Do not apply voltage between any input interlock and its corresponding return.

Note: The absolute maximum current that can be sunk by the output status relays (solid state relay pins 13-16 and magnetic relay pins 15-17-18) is 100mA.

Interlock 1 (the displayed interlock name shown on the front display can be changed with the user requirements, see 'MWF command' and Memory mapping sections for further details) is hardware-activated when pin 1 and return pin 2 are shorted.

The other interlocks have the same logic of activation; returns for Interlock 5, 6, 7 and 8 are all connected together on pin 14. Magnetic relay provides the Output status of the module: when ON, the Normally Closed contact (NC-TAP) switch opens and vice-versa.

The extreme configurability of the A36xxBS modules allows users to decide what interlocks are enabled and what not, the interlock "trip" level – i.e. LOW or HIGH – and the time of intervention (the time that an interlock signal has to be to the trip level before generating a fault condition).

This information can be set and read from the module EEPROM.

An example of mating connectors for the interlocks are *Weidmuller B2L 3.50/18/180QV9 SN BK BX model*.

3.2.2.1 Interlocks Enabling/Disabling

Each A36xxBS external interlock can be enabled and disabled by writing to the interlock enable mask to the EEPROM cell 48. A value of '1' means that the interlock is enabled while a '0' value that the corresponding interlock is disabled.

The value to be written is the ASCII string, formed by 2 hexadecimal digits, that corresponds to the binary enabling/disabling mask; the eight external interlocks are numbered from 0 to 7.

Example: if only interlocks 0, 5 and 7 needs to be enabled, the following command needs to be sent to the power supply (after having un-locked the password protection):

MWG:48:A1\r

The sent string has to be so interpreted:

A				1			
1	0	1	0	0	0	0	1
Interlock 7 <i>Enabled</i>	Interlock 6 <i>Disabled</i>	Interlock 5 <i>Enabled</i>	Interlock 4 <i>Disabled</i>	Interlock 3 <i>Disabled</i>	Interlock 2 <i>Disabled</i>	Interlock 1 <i>Disabled</i>	Interlock 0 <i>Enabled</i>

In order to make this command taking effect it is necessary to perform a 'MUP\r' (Module Update Parameters) command – see “MUP command” section for further details.

The MRG:48\r command returns a string containing the ASCII correspondent of the interlock enable mask and contains information about what interlocks are enabled and what are disabled.

3.2.2.2 Interlocks Activation States

Each A36xxBS external interlock can be chosen to trip at a HIGH or a LOW logic level. A value of '1' means that the interlock trips when the input signal to the corresponding interlock is shorted and a '0' that the corresponding interlock trips when the input is open.

The value to be written is the ASCII string, formed by 2 hexadecimal digits, that corresponds to the binary activation state mask; the eight external interlocks, as for the interlock enable/disable mask, are numbered from 0 to 7.

Example: consider that only interlocks 0, 5 and 7 are enabled – i.e. a “A1” string is contained in the EEPROM cell 48 – and interlock 0 and 5 need to trip when the corresponding input signals are shorted (LOW level) while interlock 7 when their input is open (HIGH level); the value to be written to the EEPROM cell 49 is the following:

MWG:49:80\r

The sent string has to be so interpreted:

8				0			
1	0	0	0	0	0	0	0
Interlock 7 <i>HIGH</i>	Interlock 6 <i>LOW</i>	Interlock 5 <i>LOW</i>	Interlock 4 <i>LOW</i>	Interlock 3 <i>LOW</i>	Interlock 2 <i>LOW</i>	Interlock 1 <i>LOW</i>	Interlock 0 <i>LOW</i>

In order to make this command taking effect it is necessary to perform a 'MUP\r' (Module Update Parameters) command – see “MUP command” section for further details.

Content of the interlock enable/disable mask – i.e. EEPROM cell 48 – overrides the content of the cell 49 so that the values contained in cell 49 are discarded if the corresponding bit in cell 48 is '0' (and the interlock is disabled).

The MRG:49\r command returns a string containing the ASCII correspondent of the interlock enable mask and contains information about what interlocks are activated at a LOW state and what are activated at a HIGH state.

3.2.2.3 Interlocks Intervention Time

The time of intervention for each enabled interlock on a A36xxBS module can be chosen with a 1-ms resolution.

EEPROM cells from 50 to 57 contains information on how long an interlock input signal needs to be at its “activation” level before tripping and thus generating a fault condition. Interlock 0 intervention time is stored into EEPROM cell 50 while interlock 7 into EEPROM cell 57.

Example: consider that interlocks 3 needs to trip only after 100ms it has reached its activation level. The value to be written into EEPROM memory is the following:

```
MWG:53:100\r
```

In order to make this command taking effect it is necessary to perform a 'MUP\r' (Module Update Parameters) command – see “MUP command” section for further details.

Note: values for intervention time have to be included between 0 and 10000 (i.e. 10seconds).

3.2.2.4 Interlock Configuration Example

Magnets can be water-cooled and there is a usual need for an interlock in case of the water cooling system fault.

Let's consider a water flow switch that, by choice, can be connected to interlock 2 of a SY3634 interlock connector on the rear panel.

Water flow switch signals needs to be connected between pins 3 and 4 of the interlock connector (see **Errore. L'origine riferimento non è stata trovata.**); in order to activate only interlock 2, the following command need to be sent to the A36xxBS module:

```
MWG:48:02\r
```

A correct operation of the magnet cooling keeps the interlock input pins shorted while a fault has to be generated when the input becomes open; the interlock 2 activation level needs to be set to HIGH with the following command:

MWG:49:02\r

The possible presence of air bubbles that may generate some fake faults and some voltage spikes on the interlock input contacts generates the need for a hysteresis on the interlock level: this can be obtained by simply setting the interlock 2 intervention time to a few seconds (4s for example – i.e. 4000ms) in the following way:

MWG:52:4000\r

The previous settings do not become active until a 'MUP\r' (Module Update Parameters) command is sent to the power supply module and an '#AK\r' response has been received.

3.3 EEPROM Memory Mapping

Each A36xxBS power supply module has an on-board EEPROM memory that stores all information about calibration parameters, module identification, thresholds, interlock naming and configuration, etc.

Some of these fields can be user-defined and are extremely useful in order to exactly fit the power supply to the specific application.

EEPROM memory size is 256Kbits and was divided into two main different sections, each one consisting of 128Kbits:

- **FIELD** section;
- **VALUE** section.

This section division can be seen in **Figure 9**.

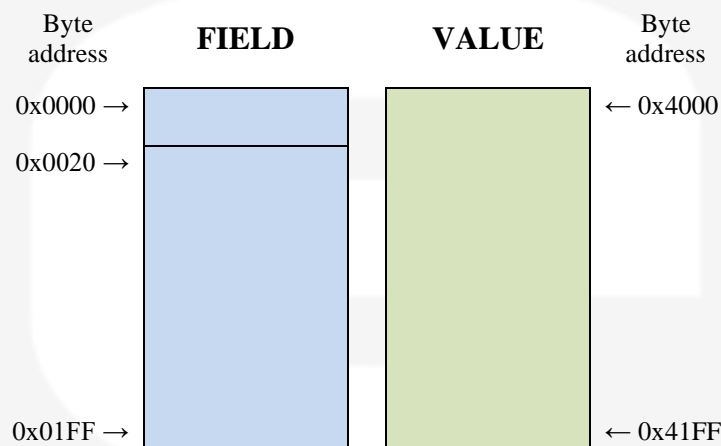

Figure 9: EEPROM memory sections

The EEPROM cell size is 0x20 bytes – i.e. 32 bytes – and, being the content stored in ASCII string format, the total string can contain 31 bytes + ‘\r’ termination character.

Some EEPROM cells are password protected and can be unlocked using the ‘PASSWORD’ command (see the corresponding section for further details).

The password used to unlock the write-protected EEPROM cells of the modules is "PS-ADMIN".

The EEPROM “**value**” structure and the cell content description are presented in **Table 2**:

Cell #	Cell Caption	Description
0	c_0I_{set}	Zero-order current calibration coefficient
1	c_1I_{set}	1 st -order current calibration coefficient
2	c_2I_{set}	2 nd -order current calibration coefficient
3	c_3I_{set}	3 rd -order current calibration coefficient
4	I_{max}	Maximum settable current set-point
5	c_0V_{read}	Zero-order voltage calibration coefficient
6	c_1V_{read}	1 st -order voltage calibration coefficient
7	c_2V_{read}	2 nd -order voltage calibration coefficient
8	c_3V_{read}	3 rd -order voltage calibration coefficient
9	c_0DC_{Link}	Zero-order DC-link calibration coefficient
10	c_1DC_{Link}	1 st -order DC-link calibration coefficient
11	c_2DC_{Link}	2 nd -order DC-link calibration coefficient
12	c_3DC_{Link}	3 rd -order DC-link calibration coefficient
13	K_P - proportional constant	PID regulator proportional gain
14	K_I - integral constant	PID regulator integrative gain
15	K_D - derivative constant	PID regulator derivative gain
18	Newton-Raphson Iterations	Number of iterations for inverse calibration
19	<i>reserved</i>	-
20	Max MOSFET Temperature	Maximum MOSFET heatsink temperature
21	Max SHUNT Temperature	Maximum shunt resistor temperature
22	Serial Number	Module serial number
23	Undervoltage Protection	Under-voltage protection threshold
24 ... 25	<i>reserved</i>	-
26	Calibration Date	Date of last calibration
27	Identification	Module identification name
28 ... 29	<i>reserved</i>	-
30	Slew Rate [A/s]	Module slew rate value
31	Earth Current Limit [A]	Maximum earth leakage current limit
32... 36	<i>reserved</i>	-
37	Regulation fault threshold [A]	Maximum allowable regulation fault current
38	<i>reserved</i>	-
39	Ripple fault threshold [A]	Maximum allowable current ripple
40 ... 46	<i>reserved</i>	-
47	Warning Enabled	Enable warning visualization
48	Interlock Enable/Disable Mask	Enabling/disabling external interlocks
49	Interlock Activation State Mask	Definition of external interlocks active state
50	Interlock 0 Intervention Time (ms)	Intervention time for interlock 0

51	Interlock 1 Intervention Time (ms)	Intervention time for interlock 1
52	Interlock 2 Intervention Time (ms)	Intervention time for interlock 2
53	Interlock 3 Intervention Time (ms)	Intervention time for interlock 3
54	Interlock 4 Intervention Time (ms)	Intervention time for interlock 4
55	Interlock 5 Intervention Time (ms)	Intervention time for interlock 5
56	Interlock 6 Intervention Time (ms)	Intervention time for interlock 6
57	Interlock 7 Intervention Time (ms)	Intervention time for interlock 7

Table 2: EEPROM “Value” section

Please note that:

- cells marked in **blue** are password-protected;
- cells marked in **green** are not accessible by the user (factory-reserved).

All settable parameters need to be updated in order to take immediate effect on the module operation: a ‘MUP\r’ command needs to be sent to the A36xxBS module after all parameters have been set by ‘MWG’ commands.

The EEPROM “**field**” structure and the cell content description are presented in **Table 3**:

Cell #	Cell Caption	Description
0 ... 49	<i>reserved</i>	-
50	Interlock 0 identification	Interlock 0 identification name/string
51	Interlock 1 identification	Interlock 1 identification name/string
52	Interlock 2 identification	Interlock 2 identification name/string
53	Interlock 3 identification	Interlock 3 identification name/string
54	Interlock 4 identification	Interlock 4 identification name/string
55	Interlock 5 identification	Interlock 5 identification name/string
56	Interlock 6 identification	Interlock 6 identification name/string
57	Interlock 7 identification	Interlock 7 identification name/string

Table 3: EEPROM “Field” section

Please note that cells marked in **blue** are password-protected and need to be unlocked in order to write their content.

Please refer to **Table 2** and **Table 3** to write values and fields to configure correctly the A36xxBS module and note that the commands to be used are:

- ‘MWG’ command to write the respective “value” cell content;
- ‘MWF’ command to write the respective “field” cell content.

The power supply controller automatically handles EEPROM addresses and “value” and “field” cell sections so that the MWF and MWG commands are almost transparent to the users and there is no need to write complicated cell addresses.

Example: suppose that the proportional term value – K_p – of the internal PID digital regulator has to be changed to 0.15. Referring to **Table 2**, this value is not password protected and it is placed at “value” section cell number 13.

The following command needs to be sent to the A36xxBS module:

MWG:13:0.15\r

and should receive an acknowledgment reply from the power supply – i.e. ‘#AK\r’. Now, the value 0.15 it is stored in the “value” cell number 13 (which is the cell 0x41A0 since the “value” section offset is equal to 0x4000 bytes and each cell length is 0x20 byte). In order to make the module apply the value $K_p = 0.15$ to its internal regulator, a ‘MUP\r’ command has to be sent.

3.3.1 “Value” Section Cells

Herein, in order to correctly configure and check the power supply operation, a brief description of the “value” section user-definable cells is presented:

- **I_{max}** – *cell 4*: the value contained in this cell defines the maximum current [A] that a user can set to the A36xxBS module. This value need to be included between a lower limit 0A and(rated output current) + 0.1A;

- **K_p** – *cell 13*: this value is the proportional gain coefficient of the internal digital PID regulator;

- **K_i** – *cell 14*: this value is the integral gain coefficient of the internal digital PID regulator;

- **K_d** – *cell 15*: this value is the derivative gain coefficient of the internal digital PID regulator;

- **Max MOSFET Temperature** – *cell 20*: this value [°C] defines the temperature threshold above what the power supply generates an over-temperature fault condition. The temperature is directly measured on the output stage MOSFETs common heatsink;

- **Max Shunt Temperature** – *cell 21*: this value [°C] defines the temperature threshold above what the power supply generates an over-temperature fault condition. The temperature is directly measured on the shunt resistor case;

- **Under-Voltage Protection** – *cell 23*: this value [V] defines the voltage threshold below what the power supply generates an under-voltage fault condition;

- **Identification** – *cell 27*: this value, a string, defines the A36xxBS module identification name (and can be read with the ‘MRID\r’ command);

- **Slew Rate** – *cell 30*: this value [A/s] determines the slew-rate value of the power supply. The module ramps, using the command ‘MRM\r’, at a defined set-point with this pre-defined value of slew-rate.

- **Earth Current Limit** – *cell 31*: this value [A] defines the maximum value allowable for the earth leakage current before generating a fault condition and disabling the output stage;

- **Regulation Fault Threshold** – *cell 37*: this value [A] defines the maximum allowable value, calculated as the difference from the actual output current set-point, before generating a fault condition;

- **Ripple Fault Threshold** – *cell 39*: this value [A] defines the maximum allowable value, calculated as the peak-to-peak output current ripple, before generating a fault condition;

- **Warning Enabled** – *cell 47*: this value defines if the warnings (i.e. bulk redundancy) are enabled or not. The setting of this flag to ‘1’ enables the visualization of the “bulk redundancy” warning on the front panel display in a yellow colour and the eventual setting of the warning bit in the status register (see “Status Register” section for further details);

- **Interlock Enable/Disable Mask**– *cell 48*: this cell contains and defines the 2-digit hexadecimal ASCII number that represents the binary mask for the individual setting of interlocks from 0 to 7 (see “Interlocks Enabling/Disabling” for further information);

- **Interlock Activation State Mask**– *cell 49*: this cell contains and defines the 2-digit hexadecimal ASCII number that represents the binary mask for the individual setting of activation state of interlocks from 0 to 7 (see “Interlocks Activation State” for further information);

- **Interlock 0 to 7 Intervention Time** – *cell 50 to 57*: this cells contains the value of the interlock intervention times in [ms] (see “Interlocks Intervention Time” for further information).

3.4 Status Register

Each A36xxBS module has an internal 32-bit status register that contains all useful information about the power supply operation; this register is updated in real-time and it is always accessible by the users via the remote connection.

The internal status register structure is presented in **Table 4****Errore. L'origine riferimento non è stata trovata.** (bit 31 is the MSB and bit 0 the LSB):

Status bit	Cell Caption
31 ... 28	<i>don't care</i>
27	BULK REDUNDANCY
26	AUX EARTH OK
25	BULK WAIT FOR STANDBY
24	BULK ON
23 ... 16	EXTERNAL INTERLOCKS [7...0]
15	RIPPLE FAULT
14	WAVEFORM EXECUTION FLAG
13	TURNING OFF
12	RAMP EXECUTION FLAG
11	REGULATOR FAULT
10	GROUND CURRENT
9	DC UNDERVOLTAGE
8	SHUNT TEMPERATURE
7	MOSFET TEMPERATURE
6	CROWBAR
5	INPUT OVERCURRENT
4	DSP ERROR - TIMEOUT
3	LOCAL
2	WARNING
1	FAULT
0	MODULE ON

Table 4: 32-bit internal status register

The status register value can be directly read by users using the 'MST\r' command. The returned item is a 4-digit hexadecimal ASCII string, corresponding to the equivalent status register. A brief description of all the binary flags is here presented:

- **Module ON** – *bit 0*: this bit is set if the module is enabled and correctly regulating output current;

- **Fault** – *bit 1*: this bit is set if the module has experienced a fault – e.g. generated by an external interlock or an internal protection trip – and the status register has not been reset;

- **Warning** – *bit 2*: this value is set if a bulk redundancy condition is present;

- **Local** – *bit 3*: this bit is set when the SY3634 where the A36xxBS module is installed is working in LOCAL mode, while this bit is cleared – i.e. set to '0' – when working in REMOTE mode;

- **DSP Error – Timeout – bit 4:** this bit is set, in conjunction with a fault condition, when the DSP executing the digital current control loop, it is not correctly operating;

- **Input Overcurrent – bit 5:** this bit is set when the input current from the bulk power supply, sensed by a Hall-effect sensor, rises above a hardware-safe threshold. The setting of this bit implies the simultaneous setting of the fault bit;

- **Crowbar – bit 6:** this bit is set when the voltage at the output terminals of the module triggers the crowbar protection (see “Internal Protections” section for further details). The setting of this bit implies the simultaneous setting of the fault bit;

- **MOSFET Temperature – bit 7:** this bit is set when a MOSFET heatsink over-temperature condition has been experienced. The setting of this bit implies the simultaneous setting of the fault bit;

- **Shunt Temperature – bit 8:** this bit is set when a shunt case over-temperature condition has been experienced. The setting of this bit implies the simultaneous setting of the fault bit;

- **DC Undervoltage – bit 9:** this bit is set when a DC-Link under-voltage condition – i.e. voltage drops below a user-defined threshold – has been recognized. As in other cases, the setting of this bit implies the simultaneous setting of the fault bit;

- **Ground Current – bit 10:** this bit is set when a fault generated by an excessive leakage current to ground has been experienced. The setting of this bit implies the simultaneous setting of the fault bit;

- **Regulator Fault – bit 11:** this bit is set when a regulation fault is experienced. The setting of this bit implies the simultaneous setting of the fault bit;

- **Ramp Execution Flag – bit 12:** this bit is set when the A36xxBS module is performing a ramp to a new set-point. After the ramp is finished, and the new set-point is reached, this flag is cleared;

- **Turning Off – bit 13:** this bit is set while the A36xxBS module is turning off. The A36xxBS modules, before disabling the output power stage, ramp down to 0A (zero) with a factory-defined slew-rate of 30A/s. This bit is always set in conjunction to the Ramp Execution Flag and it is simultaneously cleared after the ramp is finished and the output driver is disabled;

- **Waveform Execution Flag – bit 14:** this bit is set when the A36xxBS module is performing a current waveform (see “Waveform Execution” section for further details);

- **Ripple Fault – bit 15:** this bit is set when an excessive current ripple on the output current is measured by the internal logic. The setting of this bit implies the simultaneous setting of the fault bit;

- **External Interlocks** – *bit 16 ... 23*: these bits are set when the corresponding enabled external interlocks trip. These bits do not give any information about the activation state of the interlock signals. The setting of anyone of these bits implies the simultaneous setting of the fault bit;

- **Bulk ON** – *bit 24*: this bit is set when the external bulk power supply unit is enabled and delivering its DC-Link voltage to the A36xxBS module;

- **Bulk Wait For Standby** – *bit 25*: this bit was added in FPGA firmware release 1.4 (and later). This bit indicates whether or not the A36xxBS module has requested or not the bulk to turn ON with a “BON” command. Please see ”Bulk Power Supply State Machine” section for further details;

- **Aux Earth OK** – *bit 26*: this bit is set when the A3636 auxiliary power supply earth fuse blows up and generates a fault condition. In case of a setting of this bit, the fuse placed on the A3636 needs to be replaced and it implies the simultaneous setting of the fault bit;

- **Bulk Redundancy** – *bit 27*: this bit is set when redundancy in the external bulk power supply is missing; up to three external power modules can be installed in a single 1U bulk power supply: if one or two of them are faulty, or not even installed, the entire SY3634 can still work properly but it is not capable of delivering the rated power. The setting of this bit it is a warning and not a fault of the module and can be set in conjunction with the Warning bit 2 if the EEPROM “value” section cell 47 it is set to ‘1’ (see “EEPROM Memory Mapping” section for further details).

3.5 Bulk Power Supply

The bulk power converter is composed by a 1U crate where up to three AC/DC converters (FPS1000-xx) can be installed; this crate also parallels the outputs in order to have up to 120A on the output terminals.

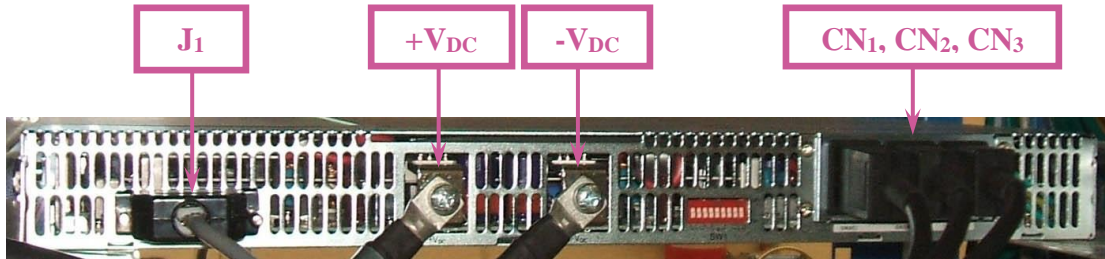

Figure 10: bulk power supply unit - rear view

The standard version of the bulk power converter provides 24V – i.e. the DC-Link voltage – to the H-Bridge of the A36xxBS power modules.

The DC-Link is fed to the SY3634 system crate and consists of an ultra-flexible 35 mm² wire and, to allow control and monitoring of the three AC/DC converters, a 7 x 0.5 mm² cable that connects the DB-25 connector provided on the back of the bulk with the SY3634 system crate (**Figure 10**).

The pinout of the DB-25 connector is summarized in **Table 5**.

Pin Contact	Function	Pin Contact	Function
1	V_TRIM_B	14	-
2	-	15	ON_OFF_B
3	DC_OK_B	16	-
4	-	17	NOT USED
5	ON_OFF_A	18	NOT USED
6	DC_OK_A	19	NOT USED
7	V_TRIM_A	20	-
8	+12V_AUX	21	-
9	-	22	SENSE -
10	V_TRIM_C	23	-
11	SIGNAL_RTN (GND)	24	-
12	DC_OK_C	25	ON_OFF_C
13	SENSE +		

Table 5: bulk power supply unit DB-25 connector pinout

The only pins used by the SY3634 system are the following ones:

- **SENS - / +**: used for remote voltage sensing;
- **V_TRIM_A / B / C**: by connecting these pins to sensing pins (SENS - / +), using two resistors, it is possible to adjust the output voltage between its maximum and minimum rated values;
- **ON_OFF_A / B / C**: the AC/DC converters A / B / C enable their outputs by connecting these pins to GND;
- **DC_OK_A / B / C**: are open-collector signals that are enabled – i.e. ON – when the output voltage is above the 80% of the rated value.

3.5.1 Bulk Power Supply State Machine

The bulk power supply is shared among all modules installed in the same SY3634 crate connected to the bulk unit.

State machine for the bulk power supply changed with **FPGA firmware release version 1.4 or later**. We recommend you to update the A36xxBS module FPGA firmware by downloading the latest version from the CAENel's website.

The state machine global block diagram is here represented:

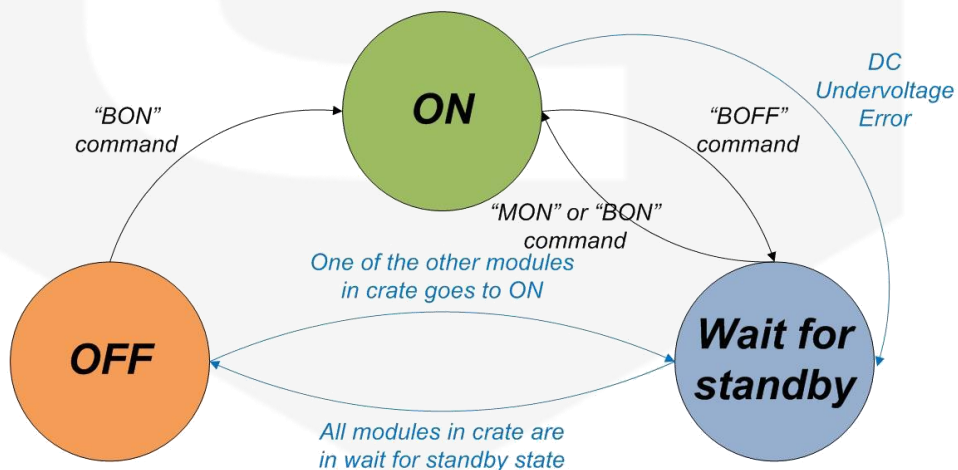

Transitions marked in **blue** are automatically performed by the module under certain conditions while transitions marked in **black** follow a specific command sent by the user.

State Machine description: if the bulk is turned on from a module by a “BON” command, the state of the bulk for the specific module goes to ON and the other modules in the crate automatically goes to a Wait for Standby situation (blue arrow). By doing this, if the module that requested the bulk PS to turn on receives a

“BOFF” command, this module goes to a Wait for Standby state and, if none of the other modules had previously requested the bulk to turn on (i.e. – they did not receive a “BON” command, the bulk power supply turns off and all of the modules go to a OFF state.

This behavior was thought in order to supply to every A36xxBS module installed in the crate a “memory” of whether or not it requested the bulk to turn on before. By doing this, if only two modules in the crate requested the bulk to turn on (or the module output to turn on – i.e. “MON” command), it is sufficient to give a “BOFF” command to only these two modules in the crate for the bulk to turn off (and not to all of them – e.g. 3 or 4 modules in the same crate).

A “Wait For Standby” bit in the A36xxBS module 32-bit internal status register (i.e. bit 25) has been added from FPGA firmware version 1.4 in order to monitor this behavior.

3.5.2 A3631 Bulk Power Supply Cable

The bulk power supply cable A3631 - shown in **Figure 11** - is used in order to connect both the power and the control signals between the bulk power supply unit and the SY3634 system crate.



Figure 11: bulk power supply cable

3.6 SHK – Sentinel Hardware Key

The Sentinel Hardware Key – short SHK – is an optional feature for connecting the bulk power supply unit to the system crate and it is shown in **Figure 12**.



Figure 12: Sentinel Hardware Key

The SHK is connected between the DB-25 connector present on the back side of the bulk crate unit and the bulk cable; when installed, it adds some functionality on the control and monitoring of the bulk power converter.

The key is particular needed when:

- the required DC-Link voltage differs from 24V (e.g. 12V);
- two or three AC/DC converters are installed in the 1U bulk crate and redundancy monitoring is required;

The printed circuit board contained the SHK connects the V_TRIM_A/B/C pins to two SMD resistors allowing the adjusting of the output voltage value.

Furthermore, on the same board, three surface mounted MOSFETs perform a logical “OR” operation (open-drain connection) of the DC_OK_A/B/C signals, feeding the resulting signal to the SY3634 crate that in turns feeds that signal to all the A36xxBS power supply modules installed in the SY3634 crate.

4. Local Control

This chapter describes the local control functionalities that are provided on each A36xxBS power supply module and some useful information on how to use it.

The entire SY3634 can be operating in LOCAL or REMOTE mode: the switch, present on the A3636 auxiliary power supply, needs to be set to **LOC** position in order to work in LOCAL mode.

After completing this operation, there should be two evidences of the power supply system being in the desired LOCAL mode:

- the REM light on the A3636 auxiliary power supply is OFF;
- a black “L” character, surrounded by a red rectangle, appears on the upper-left angle of each A36xxBS display installed in the crate (an “R” character is displayed on the same angle when working in REMOTE mode).



SY3634 set in LOCAL mode

4.1 Encoder

Each A36xxBS module can be controlled by means of the rotary encoder placed on its front panel. This encoder permits two basic actions:

- **clockwise (CW)** and **counter-clockwise (CCW) rotation** in order to change selected menu lines or numbers;
- **pushing** in order to enter sub-menus or to confirm.

The combination of the cited actions allows browsing the power supply menus to read or set desired information and parameters.

4.2 Colour Display

The colour display on each A36xxBS front panel allows users to visualize information about the power supply status and to control the unit in order to use it locally. Screens and pages of the display can be navigated from the encoder through user friendly menus and sub-menus.

4.2.1 Power-up Page

The A36xxBS, upon power-up or power-cycling, should display a yellow warning sign for a few seconds (see **Figure 13**), meaning that the power supply is correctly initializing and loading internal parameters.



Figure 13: *Power-up* display screen

After the initialization is done and internal parameters are correctly loaded, the fans should start rotating at a minimum speed level and the A36xxBS display module should go to his “Home Page” screen.

4.2.2 Home Page

The A36xxBS home page screen is the first loaded page upon power-up or power-cycling of the module, it is shown in **Figure 14**, and contains information on:

- the SY3634 LOCAL/REMOTE state;
- the A36xxBS module identification name (content of EEPROM “value” cell 27);
- output current readback value [A], with 1mA resolution;
- output voltage readback value [V], with 1mV resolution;
- status of the power supply.

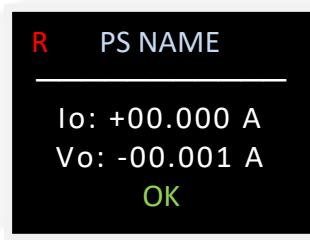

Figure 14: Home Page screen

The status indicator of the power supply is continuously blinking as it is updated (every 200 ms) and gives an indication on whether the module is operating correctly or not.

If the module has experienced one or more faults – e.g. interlock intervention, over-temperature, etc. – the home page screen would display a list of all the faults, presenting them in an alternate way, one after the other.

The power supply latches on every fault recognized by the internal logic so that every type of fault is recorded: this means that the first fault happening does not ban the other ones to be recorded so that, giving users more information, permits a better investigation on the fault cause evaluation.

For example, if the module has experienced a regulator fault and a crowbar protection intervention, the home page bottom part of the screen will switch between the red strings “REG FAULT” and “CROWBAR”.

If the module it is not turned on and the output is disabled, the home page screen should look like in **Figure 15**:

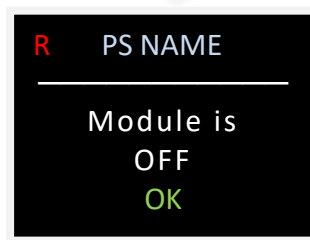

Figure 15: Home Page screen with module OFF

4.2.3 Menu Page

The menu page is reachable by clicking the encoder button while being in the home page. Through this page the users have access to all the necessary setting/monitoring functions and sub-menus of the power supply module.

The first screen shown in the Menu Page is shown in **Figure 16**:

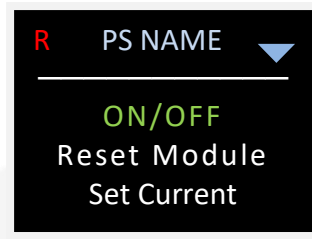

Figure 16: Menu Page screen

The accessible sub-menus from this page are herein listed (note that the selected sub-menu is lightened in green color):

- ON/OFF;
- Reset Module;
- Set Current;
- Connectivity;
- Global Stats.

A set of two blue arrows (one pointing upward and the other one downward) are shown in the upper right corner of this page in order to indicate the presence of additional sub-menu voices in the selected direction. Users can simply browse through this menu by rotating the encoder (a CW rotation makes the selection going downward in the menu while a CCW one in the opposite direction).

4.2.4 ON/OFF Page

The ON/OFF page can be reached by selecting the "ON/OFF" line in the Menu Page of the A36xxBS module.

From this page it is possible to turn on/off the bulk power supply unit connected to the module and the module itself.

In order to perform these operations it is necessary for the module to be in the LOCAL mode (indicated by a black "L" in a red frame in the upper left corner of the display), as shown in **Figure 17**:

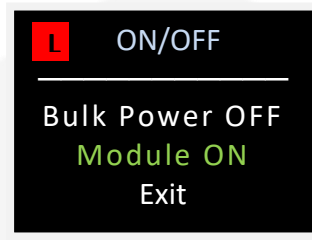

Figure 17: ON/OFF screen

The example screenshot shown in **Figure 17** allows to turn the module on while the bulk power supply is already on: this is understood by the fact that the selectable option is "Bulk Power OFF", meaning that the bulk unit is already powered.

The possible choices displayed on this menu are:

- **Bulk Power ON** (if the bulk unit is OFF);
- **Bulk Power OFF** (if the bulk unit is ON);
- **Module ON** (if the module is off and the bulk unit is ON);
- **Module OFF** (if the module is on and the bulk unit is ON).

The choice of the "Exit" line on this menu sends the users back to the Menu Page.

4.2.5 Set Current Page

The "Set Current" page allows users to locally set the current setpoint of the power supply module.

From this page it is also possible to check the actual module output current, indicated as "Io".

In order to perform the current setting operation it is necessary for the module to be in the LOCAL mode (indicated by a black "L" in a red frame in the upper left corner of the display), as shown in **Figure 18**:

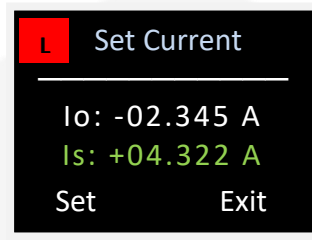

Figure 18: Set Current screen

The "Set" text in the bottom left corner of the display needs to be clicked on in order to make the new current setpoint to take effect. The power supply module A36xxBS will reach the new setpoint by ramping with the predefined slew rate, which can be checked on the "Connectivity" page of the menu.

By clicking the "Exit" text on the bottom right corner the users can go back to the Menu page.

4.2.6 Connectivity Page

The "Connectivity" page (**Figure 19**) allows user to select one of the subsequent sub-menus:

- Show MAC addr (to check the module MAC address);
- Show/Set IP (to check or change the IP address of the module);
- Exit (to return on the main menu)



Figure 19: Connectivity screen

4.2.7 MAC address page

The "MAC address" page allows users to check the module MAC (*Media Access Control*) address. An example of this page is shown in **Figure 20**.

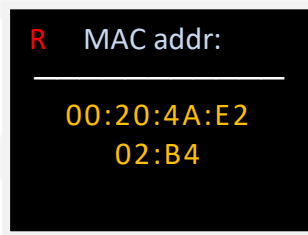

Figure 20: MAC address screen

4.2.1 IP address page

The "IP address" page allows users to check and modify the module IP (*Internet Protocol*) address.

The A36xxBS module IP address can be easily changed from this panel by selecting the new address with the local encoder in the screen shown in **Figure 21**:

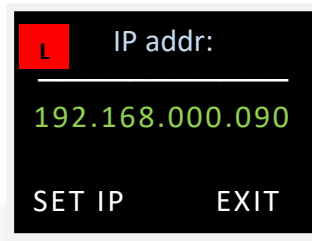

Figure 21: IP address screen

After clicking the "Set IP" text the power supply should display a window - shown in **Figure 22** - telling the users that the new IP address is configuring. The set operation can be performed only by setting the module to LOCAL mode.

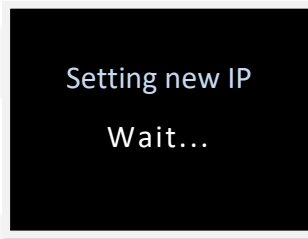

Figure 22: screenshot shown when updating IP address

It is very important to notice that once the "Set IP" text has been clicked, the user can remotely communicate and get control of the power supply again only by opening a new TCP socket to the IP that has just been set.

4.2.2 Global Stats Page

The "Global Stats" page allows users to check and monitor some of the ancillary features of the power supply module A36xxBS as DC-Link voltage, slew rate settings, etc.

An example on how the Global Stats page of the module is presented can be seen in **Figure 23**:

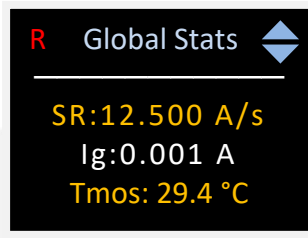

Figure 23: *Global Stats* screen

This page can be browsed by rotating the encoder and can be exited at any moment by clicking on the same encoder pushbutton (this action sends the user back to the Menu Page).

The features that can be displayed on this menu are the following:

- **DC:** the DC-Link voltage measured value [V];
- **SR:** the defined value for the slew-rate [A/s];
- **Ig:** the measured ground leakage current [A];
- **Tmos:** the measured MOSFET common heatsink temperature [°C];
- **Tsh:** the measured regulation shunt heatsink temperature [°C];
- **Pout:** the estimated output active power value [W];
- **Mod:** the model of the A36xxBS module (e.g. A3620BS);
- **FPGA:** the internal FPGA firmware version;
- **DSP:** the internal DSP firmware version.

5. Remote Control

Any A36xxBS power supply module can be also remotely controlled via a standard Ethernet 10/100 link using a predefined set of commands.

The entire SY3634, as cited in the previous section, can be operating in LOCAL or REMOTE mode: the switch, present on the A3636 Auxiliary Power Supply, needs to be set to **REM** position in order to work in REMOTE mode.

After completing this operation, there should be two evidences of the power supply system being in the desired REMOTE mode:

- the REM light on the A3636 Auxiliary Power Supply is ON;
- a red “R” character appears on the upper-left angle of each A36xxBS display installed in the crate (an “L” character is displayed on the same angle when working in LOCAL mode).



SY3634 set in REMOTE mode

5.1 Preliminary Information

In order to ensure a correct communication with an A36xxBS module, the following rules have to be pointed out:

- commands to the A36xxBS power supply module must be sent with a '\r' (carriage return, 0x0D hexadecimal number) termination character;
- replies from the A36xxBS power supply also have a '\r' (carriage return, 0x0D hexadecimal number) termination character.

A complete list of commands (except for reserved commands) is herein presented and an overview for each command syntax and functionality follows.

The extreme configurability of this power supply leads to a very widespread command list, thus typical users may only need a small set of commands in order to run the SY3634 system in a satisfying way.

5.2 List of Commands

The user-available commands, as well as a brief description and their read or write functionality, are summarized in the following table:

Command	Description	Read/Write
BON	Turn the bulk power supply ON	W
BOFF	Turn the bulk power supply OFF	W
FDB	Feedback command	W
HWRESET	Performs and hardware reset of the module	W
MAC	Read MAC and IP addresses of the module	R
MGC	Read ground leakage current value	R
MGLST	Read the main values and status of the module	R
MOFF	Turn the module OFF	W
MON	Turn the module ON	W
MRESET	Reset the module status register	W
MRF	Read selected EEPROM "field" cell	R
MRG	Read selected EEPROM "value" cell	R
MRH	Read hexadecimal raw ADC value	R
MRI	Read output current value	R
MRID	Read module identification	R

MRM	Set output current value (ramp)	W
MRP	Read DC-Link voltage value	R
MRT	Read output stage heatsink temperature	R
MRTS	Read regulation shunt temperature	R
MRV	Read output voltage value	R
MRW	Read estimated active output power value	R
MSP	Read last stored output current setpoint	R
MSR	Read or write slew-rate value	R/W
MST	Read module internal status register	R
MUP	Update all EEPROM parameters	W
MWAVE	Set waveform total number of points	W
MWAVEP	Set waveform single point	W
MWAVER	Read stored waveform points	R
MWAVESTART	Start waveform execution	W
MWAVESTOP	Stop waveform execution	W
MWF	Write selected EEPROM “field” cell	W
MWG	Write selected EEPROM “value” cell	W
MWH	Write hexadecimal raw ADC value	W
MWI	Set output current value (no ramp)	W
PASSWORD	Write password to unlock password-protected cells	W
PTP	Refresh digital PID regulator parameters	W
SIP	Set module IP address	W
VER	Read module model and installed firmware versions	R

Table 6: A36xxBS module Command List

It is important to notice that some commands are write-only commands (e.g. MRM to set output current) and some others are read-only commands (e.g. MRI to read output current value).

The only command that allows reading and setting is the MSR command, which reads or sets the user-defined slew-rate for the power supply (see ‘MSR Command’ section for further details).

5.3 Commands Overview

The power supply controller replies every time that a termination character '\r' is received. Replies could have different behaviors:

- an acknowledgment '#AK\r' string is sent back in case of a correct setting command;
- a non-acknowledgment '#NAK\r' string is sent back in case of a wrong/unrecognized command or if the system is in local operation mode and a write command is sent to the controller (write commands are marked with a 'W' in **Errore. L'origine riferimento non è stata trovata.**);
- a standard reply, preceded by a '#' and followed by a '\r' character, is sent back as a response to a reading command.

A brief description for each command, in alphabetical order, is herein presented with some example annotations; the correct interpretation for these examples is as follows:

Command sent TO the power supply → ← **Reply FROM the power supply**

5.3.1 “BOFF” Command

The ‘BOFF\r’ command is intended to turn off the external bulk power supply unit connected to the SY3634 crate where the A36xxBS module is installed by driving low the bulk output stage enabling signal.

It is necessary to send the ‘BOFF\r’ command to all the A36xxBS modules connected to the bulk (up to four per crate) in order to effectively turn the bulk OFF; this was done in order not to deprive a working module from the necessary power even if another one, installed into the same crate, does not need the bulk power anymore.

All the A36xxBS modules are equipped with dedicated logic that allows a module to know whether the other ones need the bulk power supply to be on or not.

As soon as all the modules receive a ‘BOFF\r’ command, the bulk power supply turns off.

It is important to notice that the bulk power supply cannot be turned off directly with ‘BOFF\r’ if the module is in ON state and output current terminals are enabled; it is necessary to turn the A36xxBS module OFF first.

Replies from the A36xxBS to a ‘BOFF\r’ command are in the form ‘#AK\r’ or ‘#NAK\r’; the ‘#NAK\r’ reply is obtained if:

- the SY3634 system is in LOCAL mode;
- the A36xxBS module is ON, i.e. output current terminals are enabled.

Examples:

BOFF example when the A36xxBS module is in LOCAL mode:

BOFF\r → ← #NAK\r

BOFF example while the A36xxBS module is enabled – i.e. it is ON:

BOFF\r → ← #NAK\r

BOFF example when the A36xxBS module is OFF:

BOFF\r → ← #AK\r

5.3.2 "BON" Command

The 'BON\r' command turns on the external bulk power supply unit connected to the SY3634 crate where the A36xxBS module is installed by shorting the bulk output stage enabling contacts.

Any of the A36xxBS modules installed in the same SY3634 crate can turn on the bulk power supply with a 'BON\r'; after sending a 'BON\r' command to a single A36xxBS module, all the other modules installed in the same crate recognize that the bulk power supply is turned ON and there is no need to send other 'BON\r' commands.

Replies from the A36xxBS to a 'BOFF\r' command are in the form '#AK\r' or '#NAK\r'; the '#NAK\r' reply is obtained if:

- the SY3634 system is in LOCAL mode;

Examples:

BON example when the A36xxBS module is in LOCAL mode:

BON\r → ← #NAK\r

BON example when the bulk is off:

BON\r → ← #AK\r

5.3.3 “FDB” Command

The ‘FDB’ command is a custom command that was especially implemented in order to minimize traffic on the Ethernet communication socket, having a dedicated request/reply structure.

The feedback command syntax is as follows:

FDB:set_reg:i_set\r

where:

- *set_reg*: is the setting register of the power supply (8-bit wide);
- *i_set*: is the desired output current setpoint value [A].

The power supply reply, after a FDB command, it is in the following format:

#FDB:status_reg:i_set:i_read\r

where

- *status_reg*: is the 32-bit wide *status register* of the PS, formatted in an hexadecimal string; this status string has a fixed-length of 8-byte;
- *i_set*: is the string containing the output current desired setpoint value; string length is 8 bytes (i.e. 8 characters): sign + 2 integers + "." + 4 decimal digits (eg. 1,02A it is returned as +01.0200);
- *i_read*: is the output current readback string; its length is equal to 8 bytes: sign + 2 integers + "." + 4 decimal digits;

The *status_reg* structure is presented in the following table (and in section 3.4):

Status Register Structure (32-bit)	
Bit 31...28	<i>don't care</i>
Bit 27	BULK REDUNDANCY
Bit 26	AUX EARTH OK
Bit 25	WAIT FOR STANDBY
Bit 24	BULK STATUS (ON = 1)
Bit [23:16]	EXTERNAL INTERLOCKS
Bit 15	RIPPLE FAULT
Bit 14	WAVEFORM EXECUTION FLAG
Bit 13	TURNING OFF
Bit 12	RAMP EXECUTION FLAG

Bit 11	REGULATOR FAULT
Bit 10	GND CURRENT
Bit 9	DC UNDERVOLTAGE
Bit 8	SHUNT TEMP
Bit 7	MOSFET TEMP
Bit 6	CROWBAR
Bit 5	INPUT OVERCURRENT
Bit 4	DSP ERROR (TIMEOUT)
Bit 3	LOCAL
Bit 2	WARNING
Bit 1	FAULT
Bit 0	MODULE ON

The *set_reg* structure, in order to set the desired behaviour, must be interpreted as follows:

FDB command register (8bit):	Bit Function:
Bit 7	BYPASS COMMAND
Bit 6	ON/OFF
Bit 5	RESET
Bit 4	RAMP
Bit 3	BULK ON/OFF
Bit 2...0	<i>don't care</i>

Example:

Suppose that the PS is ON and it is regulating at a 5.0000A output current. The user then sends the following command:

FDB:58:-03.2453\r

#FDB:00061001:-03.2453:+05.0000\r

After sending the FDB command, the PS turns on (it was already ON) and sets its current to -3.2453A reaching this setpoint with a ramp (defined by the slew rate value stored in the PS non-volatile memory).

The entire reply from the power supply, referred to the format just presented, can be interpreted as follows:

- Module is ON;
- Ramp is executing (Ramp execution flag);
- Bulk is ON;
- Auxiliary PS earth fault is OK.
- actual output current value is 5.0000A;
- the new set-point is -3.2453A.

5.3.4 “HWRESET” Command

The ‘HWRESET\r’ command performs a complete reset of the hardware and firmware of the on-board FPGA and DSP, thus re-initializing the entire A36xxBS module control electronics.

Replies from the power supply are in the form ‘#AK\r’, or ‘#NAK\r’; this non-acknowledgment reply is generated when:

- the SY3634 system is in LOCAL mode;
- the A36xxBS module is ON (it is necessary to turn the module OFF first in order to perform a remote hardware reset).

Examples:

HWRESET example with the module in LOCAL mode:

HWRESET\r → ← #NAK\r

HWRESET example with the module in LOCAL mode:

HWRESET\r → ← #AK\r

It is important to notice that the A36xxBS replies with an acknowledgment command “#AK\r” before resetting the internal hardware and firmware. After reset, the communication to the power supply module can be lost for a few seconds as a consequence of re-initialization.

5.3.5 “MAC” Command

The ‘MAC\r’ command returns both the MAC address and IP address of the connected A36xxBS power supply in the following form:

#MAC:mac_addr:ip_addr\r

where:

- *mac_addr* is the MAC address of the module;
- *ip_addr* is the IP address of the module.

The MAC command, being a reading command, returns a response in any module condition (e.g. local/remote).

Examples:

MAC example:

MAC\r → #MAC:00204AD4ED5B:192.168.0.10\r

5.3.6 “MGC” Command

The ‘MGC\r’ command returns the readback value of the actual ground leakage current of the A36xxBS power supply in the following form:

#MGC:value\r

where:

- *value* is the earth current value read [A].

The MGC command, being a reading command, returns a response in any module condition (e.g. local/remote).

Examples:

MGC example for a 60mA ground leakage current:

MGC\r → #MGC:0.06\r



5.3.7 “MGLST” Command

The ‘MGLST\r’ command is a general purpose reading command that returns some useful readback values as well as the power supply global status.

Replies from the A36xxBS module are in the following form:

```
#MGLST:i_out:v_out:status:i_gnd:i_set\r
```

where:

- *i_out* is the output current value readback [A];
- *v_out* is the output voltage value readback [V];
- *status* is the ASCII representation, composed by eight hexadecimal digits, of the module 32-bit status register;
- *i_gnd* is the ground leakage current read [A];
- *i_set* is the last stored output current setpoint [A].

The MGLST command, being a reading command, returns a response in any module condition (e.g. local/remote).

Examples:

MGLST example for an A36xxBS module set to -13.0355A:

```
MGLST\r → #MGLST:-13.0356:-5.4321:0003:0.00:-13.0355\r
```

5.3.8 “MOFF” Command

The ‘MOFF\r’ command is intended to turn off the A36xxBS output driver, thus disabling the output current terminals.

The ‘MOFF\r’ command automatically sets output current to 0A (zero) with a 30A/s factory default slew-rate before disabling the output drivers; this is done in order to avoid voltage overshoots - that would be anyway smoothed and limited by the crowbar and over-voltage clamping protections - especially for high currents and strongly inductive loads.

Replies from the A36xxBS to a ‘MOFF\r’ command are in the form ‘#AK\r’ or ‘#NAK\r’; the ‘#NAK\r’ reply is obtained if:

- the SY3634 system is in LOCAL mode;

Sending a ‘MOFF\r’ command when the module output is already disabled generates an acknowledgment response – i.e. ‘#AK\r’.

Examples:

MOFF example when the A36xxBS module output is already disabled:

MOFF\r → #AK\r

MOFF example when the system is in LOCAL mode:

MOFF\r → #NAK\r

MOFF example when the A36xxBS module is ON and sourcing current:

MOFF\r → #AK\r

5.3.9 “MON” Command

The ‘MON\r’ command is intended to turn on the A36xxBS output driver, thus enabling the output current terminals and allowing the power supply to regulate and feed current to the connected load.

After the reception of an ‘MON\r’ command, the power supply automatically sets output current to 0A (zero) when enabling the output.

Replies from the A36xxBS to a ‘MOFF\r’ command are in the form ‘#AK\r’ – when the command is correctly executed - or ‘#NAK\r’. The ‘#NAK\r’ reply is obtained if:

- the SY3634 system is in LOCAL mode;
- the bulk power supply is not enabled (see ‘BON\r’ command for further details);
- the A36xxBS module is in a FAULT condition (it is necessary to reset the status register after a generic fault condition in order to turn the power supply ON again - see command ‘MRESET\r’).

Sending an ‘MON\r’ command when the module output is already enabled generates a non-acknowledgment response – i.e. ‘#NAK\r’.

Examples:

MON example when the bulk power supply is enabled (ON) and no fault conditions:

MON\r → ← #AK\r

MON example when the system is in LOCAL mode:

MON\r → ← #NAK\r

MON example when the bulk power supply is still disabled (OFF):

MON\r → ← #NAK\r

5.3.10 “MRESET” Command

The ‘MRESET\r’ command has to be used in order to perform a complete reset of the module status register: this is needed, for example, to enable the channel output again after a fault condition has been fixed.

Reply from the A36xxBS module is ‘#AK\r’ if the module is set in REMOTE mode and ‘#NAK\r’ if in LOCAL mode.

Examples:

MRESET example when A36xxBS in LOCAL mode:

MRESET\r → ← #NAK\r

MRESET example when A36xxBS in REMOTE mode:

MRESET\r → ← #AK\r

5.3.11 “MRF” Command

The ‘MRF\r’ command returns the value stored in the “field” parameter of a desired EEPROM cell. The correct form for the reading request is as follows:

MRF:cell_num\r

where:

- *cell_num* is the EEPROM cell number.

The on-board EEPROM memory - used to store module information as calibration parameters, identification, thresholds – has 512 cells, so that *cell_num* is limited between 0 and 511; requests containing cell values exceeding these limits obtain a non-acknowledgment reply ‘#NAK\r’. The “field” section of the EEPROM is used to store interlocks identification names (cells 50 to 57); for more information on how to write parameters in the “field” area of the memory, please refer to “MWF Command” section.

Replies from the A36xxBS power supply are in the following format:

cell_content\r

where:

- *cell_content* is the *cell_num* content in an ASCII representation.

The MRF command, being a reading command, returns a response in any module condition (e.g. local/remote); this reply is a “#NAK\r” also if the memory cell is empty.

Examples:

MRF example with cell_num out of limits:

MRF:539\r →

← #NAK\r

MRF example for a user-defined interlock-related cell:

MRF:52\r →

← THERMAL_SWITCH1\r

5.3.12 “MRG” Command

The ‘MRG\r’ command returns the value stored in the “value” parameter of a desired EEPROM cell. The correct form for the reading request is as follows:

MRG:cell_num\r

where:

- *cell_num* is the EEPROM cell number.

The on-board EEPROM memory - used to store module information as calibration parameters, identification, thresholds – has 512 cells, so that *cell_num* is limited between 0 and 511; requests containing cell values exceeding these limits obtain a non-acknowledgment reply ‘#NAK\r’.

A non-acknowledgment response – i.e. ‘#NAK\r’ – is returned also if the field *cell_num* is empty.

The “value” section of the EEPROM is used to store calibration parameters, identification, thresholds, interlock information, etc. and other user-definable factors. For more information on how to write parameters in the “value” area of the memory, please refer to “MWG Command” section.

Replies from the A36xxBS power supply are in the following format:

cell_content\r

where:

- *cell_content* is the *cell_num* content in an ASCII representation.

The MRG command, being a reading command, returns a response in any module condition (e.g. local/remote); this reply is a “#NAK\r” also if the memory cell is empty.

Examples:

MRG example with cell_num out of limits:

MRG:675\r → ← #NAK\r

MRG example for cell 31 (containing earth current threshold [A]):

MRG:31\r → ← 0.2\r

MRG example for cell 23 (containing DC undervoltage threshold [V]):

MRG:23\r → ← 0.2\r

5.3.13 “MRH” Command

The ‘MRH\r’ command returns the raw hexadecimal value of the power supply current regulation ADC; this value has a 16-bit resolution and was mainly implemented for debugging purposes.

Replies from the power supply A36xxBS controller to this command are in the following format:

#MRH:value\r

where:

- *value* is the hexadecimal representation of the raw current ADC value (4-character representation).

The MRH command, being a reading command, returns a response in any module condition (e.g. local/remote).

Examples:

MRH example:

MRH\r →

← #MRH:2F3A\r

5.3.14 “MRI” Command

The ‘MRI\r’ command returns the readback value of the power supply actual output current.

Current readback values have a 20-bit resolution (19-bit + sign) and they are presented with a 5-digit precision.

Replies from the power supply A36xxBS controller to this command are in the following form:

#MRI:value\r

where:

- *value* is the output current value readback [A].

The MRI command, being a reading command, returns a response in any module condition (e.g. local/remote).

Examples:

MRI example when the module is OFF:

MRI\r → #MRI:+0.00004\r

MRI example when the module is ON and regulating:

MRI\r → #MRI:-28.34563\r

5.3.15 “MRID” Command

The ‘MRID\r’ command returns the A36xxBS module identification name as a string.

The reply from the power supply contains the value stored in cell 27 of the module EEPROM and it assumes the following format:

#MRID:module_id\r

where:

- *module_id* is the module identification stored in non-volatile memory, as an ASCII string.

This command is equivalent to the ‘MRG:27\r’ command, being the cited cell content the user-selected module identification name.

The MRID command, being a reading command, returns a response in any module condition (e.g. local/remote).

Examples:

MRID example with the module identification “SkewMag1.3”:

MRID\r → #MRID:SkewMag1.3\r

5.3.16 “MRM” Command

The ‘MRM’ command is used to set the value of the desired output current set-point:

MRM:value\r

where:

- *value* is the output current desired set-point [A].

The difference between the ‘MWI\r’ command and the ‘MRM\r’ command is that the first one generates a direct change in output current characterized by the PID regulator parameters (slew-rate value is discarded and the command is ideally suited for small output current changes and feedback purposes) while the second one makes the power supply go from the previous to the actual current value performing a ramp, defined by a slew-rate (in A/s) stored in the EEPROM cell 30.

The A36xxBS module responds with acknowledgment command ‘#AK\r’ if the value is correctly set and with a ‘#NAK\r’ if:

- the set *value* is out-of-range (the maximum settable current value is user-defined and stored in EEPROM cell 4);
- the module is OFF (it is necessary to turn the module ON first);
- the module performing a ramp (it is necessary to wait for the power supply to end the previous ramp) or a waveform;
- the system is in LOCAL mode.

Examples:

MRM example with the A36xxBS module in OFF state:

MRM:-11.872\r →

← #NAK\r

MRM example with the A36xxBS module ON and not ramping nor performing a waveform:

MRM:3.1234\r →

← #AK\r

5.3.17 “MRP” Command

The ‘MRP\r’ command returns the value of the bulk power supply actual voltage, i.e. DC Link, measured at the A36xxBS module input terminals.

Readback values have a unipolar 16-bit resolution (i.e. no sign).

Replies from the power supply A36xxBS controller to this command are in the following format:

#MRP:value\r

where:

- *value* is the measured DC Link voltage [V].

Even if the internal ADC dedicated to this purpose has a 16-bit resolution, this value is presented to the user only with a 100 mV resolution.

The MRP command, being a reading command, returns a response in any module condition (e.g. local/remote).

Examples:

MRP example when the bulk power supply is disabled:

MRP\r → #MRP:0.0\r

MRP example when the bulk power supply is enabled (after a ‘BON\r’ command):

MRP\r → #MRP:24.2\r

5.3.18 “MRT” Command

The ‘MRT\r’ command returns the value of the temperature directly measured on the output stage MOSFET heatsink.

Even if the internal ADCs have a 16-bit resolution, this value is presented to the user with a 0.1 °C (= 0.1 K) resolution.

Replies from the power supply A36xxBS controller to this command are in the following form:

#MRT:value\r

where:

- *value* is the temperature value [°C = Celsius] measured on the output stage heatsink.

The MRT command, being a reading command, returns a response in any module condition (e.g. local/remote).

Examples:

MRT example:

MRT\r



#MRT:32.8\r



5.3.19 “MRTS” Command

The ‘MRTS\r’ command returns the value of the temperature directly measured on the regulation shunt resistor heatsink.

Even if the internal ADCs have a 16-bit resolution, this value is presented to the user with a 0.1 °C (= 0.1 K) resolution.

Replies from the power supply A36xxBS controller to this command are in the following form:

#MRTS:value\r

where:

- *value* is the temperature value [°C = Celsius] measured on the regulation shunt resistor heatsink.

The MRTS command, being a reading command, returns a response in any module condition (e.g. local/remote).

Examples:

MRT example:

MRTS\r



#MRT:36.3\r



5.3.20 “MRV” Command

The ‘MRV\r’ command returns the readback value of the power supply actual output voltage, measured at the A36xxBS module output terminals.

As for the output current, voltage readback values have a 20-bit resolution (19-bit + sign) and they are presented with a 5-digit precision.

Replies from the power supply A36xxBS controller to this command are in the following form:

#MRV:value\r

where:

- *value* is the output voltage readback [V], measured at the module output terminals.

The MRV command, being a reading command, returns a response in any module condition (e.g. local/remote).

Examples:

MRV example when the module is OFF:

MRV\r → #MRV:+0.00012\r

MRV example when the module is ON and regulating output current:

MRV\r → #MRV:-28.34563\r

5.3.21 “MRW” Command

The ‘MRW\r’ command returns the actual value of the estimated active power supplied to the connected load.

This estimation, being computed as the product of the output voltage and the output current readback values, has the same 20-bit resolution and it is presented with a 5-digit precision.

Replies from the power supply A36xxBS controller to this command are in the following form:

#MRW:value\r

where:

- *value* is the output active power readback [W], estimated as the product of output voltage and output current readbacks.

The MRW command, being a reading command, returns a response in any module condition (e.g. local/remote).

Examples:

MRW example when the module is OFF:

MRW\r → #MRW:-0.00432\r

MRW example when the module is ON and regulating output current:

MRW\r → #MRW:+411.32345\r

5.3.22 “MSP” Command

The ‘MSP\r’ command returns the value of the power supply last stored set-point current value.

Replies from the power supply A36xxBS controller to this command are in the following form:

#MSP:value\r

where:

- *value* is the last stored output current set-point value [A].

The MSP command, being a reading command, returns a response in any module condition (e.g. local/remote).

Examples:

MSP example when the module is OFF:

MSP\r → #MSP:+1.23456\r

5.3.23 “MSR” Command

The ‘MSR’ command is the only read/write command for the A36xxBS and allows reading and setting of the value of the slew rate, in A/s, of the power supply.

The reading command is structured as follows:

MSR:?\r

and the related reply format is:

#MSR:value\r

where:

- *value* is actual slew-rate value for the power supply [A/s], that is the content of the EEPROM cell 30, with a 5-digit precision.

The value of the slew-rate can also be set, between lower limit of 0 A/s and upper limit of 1000 A/s, using the MSR command and adopting the following syntax:

MSR:set_value\r

where:

- *set_value* is desired slew-rate value [A/s].

The MSR setting command generates, upon reception, an acknowledgment – i.e. ‘#AK\r’ - reply if the value is correctly set and with a ‘#NAK\r’ if:

- the set *value* is incorrect (e.g. out of limits);
- the module is still performing a ramp (it is necessary to wait for the power supply to end the previous ramp) or is performing a waveform,
- the system is in LOCAL mode.

Examples:

MSR reading example:

MSR:?\r → ← **#MSR:15.00000\r**

MSR setting example with a value out of limits:

MSR:13005\r → ← **#NAK\r**

MSR setting example to a correct value:

MSR:5.5\r → ← **#AK\r**

5.3.24 “MST” Command

The ‘MST\r’ command returns the value of the power supply internal status register (32 bit).

Replies from the A36xxBS power supply module to this command are in the following format:

#MST:value\r

where:

- *value* is the ASCII representation of the internal status register value, composed by 8 hexadecimal digits, and corresponding to the 32-bit wide status register.

The MST command, being a reading command, returns a response in any module condition (e.g. local/remote).

Examples:

MST example with the module ON, ramping and in LOCAL mode:

MST\r



#MST:01000009\r



5.3.25 “MUP” Command

The ‘MUP\r’ (Module UPdate) command performs an update of the power supply A36xxBSactual parameters with the parameters read from the module EEPROM.

As an example, the MWF command updates only the content of the selected EEPROM field but not the corresponding A36xxBS parameters. In order to make the module update its parameters it is necessary to perform the ‘MUP\r’ command: this was done not to apply wrong or undesired transmitted values on-the-fly without wanting it.

Replies from the power supply are in the form ‘#AK\r’, or ‘#NAK\r’; this non-acknowledgment reply is generated when:

- the SY3634 system is in LOCAL mode;
- the A36xxBS module is ON (it is necessary to shut-down the channel with MOFF command first).

Examples:

MUP example with the module OFF and system in REMOTE mode:

MUP\r → #AK\r

MUP example with the module ON and/or in LOCAL mode:

MUP\r → #AK\r

5.3.26 “PTP” Command

The ‘PTP\r’ command performs an update of the A36xxBS power supply PID controller regulation parameters (PTP = Parameters Transfer Protocol).

This command reads the updated parameters with MUP command first and then sends them to the PID controller (that needs to be used by the DSP).

For example: to modify the PID parameters it is necessary to modify the content of the respective EEPROM fields and then to execute the commands MUP and PTP.

Replies from the power supply are in the form ‘#AK\r’, or ‘#NAK\r’; this non-acknowledgment reply is generated when:

- the SY3634 system is in LOCAL mode;
- the A36xxBS module is ON (it is necessary to disable the channel with the MOFF command first for safety purposes);

Examples:

PTP example with the module OFF and in REMOTE mode:

PTP\r → #AK\r

PTP example with the module ON and/or in LOCAL mode:

PTP\r → #NAK\r

5.3.27 “SIP” Command

The ‘SIP’ command allows setting remotely the A36xxBS power supply module IP address.

In order to set a new IP address to a module it is necessary to know the actual one (this is possible by checking the “Connectivity” menu on the local color display of the module or by using the DeviceInstaller® software that can be found at www.lantronix.com).

The correct format syntax for this command is:

SIP:ip_addr\r

where:

- *ip_addr* is desired new IP address for the connected module is formed by four decimal numbers (each ranging from 0 to 255) separated by dots;

Replies from the power supply are in the form ‘#AK\r’, or ‘#NAK\r’; this non-acknowledgment reply is generated when:

- the SY3634 system is in LOCAL mode;
- the A36xxBS module is ON (it is necessary to disable the channel with the MOFF command first for safety purposes);
- the passed IP address is incorrect.

Examples:

SIP example with a correct IP address:

SIP:192.168.0.55\r → ← #AK\r

After this command, the Ethernet module on the A36xxBS reinitializes and connection to the host is lost.

SIP example with the system in LOCAL mode:

SIP:192.168.0.55\r → ← #NAK\r

SIP example with an incorrect IP address:

SIP:192.168.0.55\r → ← #NAK\r

It is very important to notice that once the SIP command has been executed, the user can communicate and get control of the power supply again only by opening a new TCP socket to the IP that has just been set.

5.3.28 “VER” Command

The ‘VER\r’ command returns information about the A36xxBS module model and the currently installed firmware versions.

The response to a ‘VER\r’ command is in the following format:

```
#VER:model:FPGA_ver:DSP_ver\r
```

where:

- *model* is the A36xxBS module model (e.g. A3605BS, A3610BS, A3620BS, A3630BS);
- *FPGA_ver* is the FPGA firmware version currently installed on the module;
- *DSP_ver* is the DSP firmware version currently installed on the module;

It is important to notice that A36xxBS modules include two firmware versions – one for the FPGA and one for the control DSP – keep them up to date by checking for updates/upgrades on the website (www.caenels.com).

The VER command, being a reading command, returns a response in any module condition (e.g. local/remote).

Examples:

VER example:

```
VER\r → #VER:A36320BS:1.0.1:2.1\r
```

5.3.29 “MWAVE” Command

The ‘MWAVE’ has to be used to load current waveform points that can be subsequently executed; the A36xxBS module has the capability of executing a pre-loaded waveform with a 1-ms update period (i.e. 1 kHz update rate).

The correct format for this command is as follows:

MWAVE:sample_num:sample_value\r

where:

- *sample_num* is sample number of the waveform, ranging from 0 – i.e. the first sample – to the last sample number, defined by (*tot_points* – 1) (see MWAVEP command for details);
- *sample_value* is the sample current set-point value [A].

Replies from the power supply are in the form ‘#AK\r’, or ‘#NAK\r’; this non-acknowledgment reply is generated when:

- the SY3634 system is in LOCAL mode;
- the A36xxBS module is executing a waveform;
- the *sample_num* value is greater than the one defined for the number of points of the pre-loaded waveform (by a MWAVEP command);
- the *sample_value* of the current is greater than the maximum value defined for the settable current (defined in EEPROM “value” cell #4).

Examples:

MWAVE correct example:

MWAVE:15:-6.32255\r →

← #AK\r

MWAVE example with a sample_num greater than the waveform length (MWAVEP):

MWAVE:15:-6.32255\r →

← #NAK\r

5.3.30 “MWAVEP” Command

The ‘MWAVEP’ command defines the maximum number of points – i.e. length – of a pre-loaded point-by-point current waveform.

The correct format for this command is as follows:

MWAVEP:tot_points\r

where:

- *tot_points* is the total number of points of the waveform (ranging from 0 – i.e. no-points – to 60000 – i.e. 60-second waveform).

Replies from the power supply are in the form ‘#AK\r’, or ‘#NAK\r’; this non-acknowledgment reply is generated when:

- the total number of points *tot_points* is out of range;
- the SY3634 system is in LOCAL mode;
- the A36xxBS module is executing a waveform.

Examples:

MWAVEP correct example:

MWAVEP:2000\r → ← #AK\r

MWAVEP example with the module performing a waveform:

MWAVEP:2000\r → ← #NAK\r

5.3.31 “MWAVER” Command

The ‘MWAVER’ command returns the value of the selected current waveform set-point sample.

The value returned by this command is the same one that was previously stored with a MWAVE command use.

The correct format for this command is as follows:

MWAVER:sample_num\r

where:

- *sample_num* is the index of the selected sample which value has to be returned.

The MWAVER command, being a reading command, returns a response in any module condition (e.g. local/remote) except if *sample_num* is over the defined range.

Replies from the A36xxBS module are in the following format:

#MWAVER:value\r

where:

- *value* is the current value stored in the selected sample.

Examples:

MWAVER example for a correct request:

MWAVER:264\r → ← #MWAVER:1.45323\r

MWAVER example for a sample_num value out of range:

MWAVER:180000\r → ← #NAK\r

5.3.32 “MWAVESTART” Command

The ‘MWAVESTART’ command is used to make the A36xxBS module execute the pre-defined loaded waveform.

The correct form format for this command is as follows:

MWAVESTART:cycles\r

where:

- *cycles* is the total number of periods that the waveform has to be executed (its period length can be defined using the MWAVEP command).

The module can execute the current waveform for a fixed number of periods ranging from 1 to 1440 (equal to a 24-hour total execution time for a 60000 points waveform).

The infinite execution of the waveform is also possible and it is obtained by passing to power supply a -1 value, so that:

‘MWAVESTART:-1\r’

repeats the waveform for an INFINITE number of cycles

Replies from the power supply are in the form ‘#AK\r’, or ‘#NAK\r’; this non-acknowledgment reply is generated, as it is for the MRM command, when:

- the SY3634 system is in LOCAL mode;
- the module is still performing a ramp (it is necessary to wait for the power supply to end the previous ramp) or it is performing a waveform;
- the module is OFF (it is necessary to turn the module ON first);
- the number of cycles value is out-of-range – i.e. greater than 1440.

Examples:

MWAVESTART example with an excessive number of cycles:

MWAVESTART:1458\r →

← #NAK\r

MWAVESTART example that starts an infinite waveform:

MWAVESTART:-1\r →

← #AK\r

MWAVESTART example that repeats the waveform for 20 cycles:

MWAVESTART:20\r →

← #AK\r

5.3.33 “MWAVESTOP” Command

The ‘MWAVESTOP\r’ stops the execution of a running waveform (that was previously started with a MWAVESTART command).

This command immediately stops the execution of the stored current waveform that is running and ramps down current to 0A (zero) with the factory default slew-rate of 30A/s.

Replies from the power supply are in the form ‘#AK\r’, or ‘#NAK\r’; this non-acknowledgment reply is generated, as it is for the MRM command, when:

- the SY3634 system is in LOCAL mode;
- the module is not executing a waveform;

Examples:

MWAVESTOP example when module is not performing a waveform or is in LOCAL:

MWAVESTOP\r → ← #NAK\r

MWAVESTOP example with a waveform running:

MWAVESTOP\r → ← #AK\r

5.3.34 “MWF” Command

The ‘MWF’ command lets users write a desired “field” item in a defined EEPROM cell.

The correct form format for this command is as follows:

MWF:cell_num:cell_content\r

where:

- *cell_num* is the EEPROM cell number;
- *cell_content* is the ASCII content to be written to the EEPROM cell *cell_num*.

The on-board EEPROM memory - used to store module information as calibration parameters, identification, thresholds and divided in two sections, “field” and “value” – has 512 cells, so that *cell_num* is limited between 0 and 511; writing operations containing cell values exceeding these limits obtain a non-acknowledgment reply ‘#NAK\r’.

This “field” section of the EEPROM is used to store descriptive items as interlocks identification names (cells 50 through 57).

Replies from the power supply are in the form ‘#AK\r’, or ‘#NAK\r’; this non-acknowledgment reply is generated when:

- the SY3634 system is in LOCAL mode;
- the cell number *cell_num* is out-of-range (negative or greater than 511);
- *cell_num* or *cell_content* are empty strings;
- the selected cell is password protected and password protection is not unlocked (see ‘PASSWORD\r’ command for further details).

Examples:

MWF example with the system in LOCAL mode:

MWF:52:INTERLOCK_A\r →

← #NAK\r

MWF correct example(after password is unlocked):

MWF:52:INTERLOCK_A\r →

← #AK\r

5.3.36 “MWH” Command

The ‘MWH’ is used in order to set the hexadecimal raw value for the power supply current regulation ADC; this command has a 16-bit resolution and was mainly implemented for debugging purposes.

This correct syntax for this command is as follows:

MWH: value\r

where:

- *value* is the hexadecimal representation of the set-point raw current ADC value (4-character representation).

Replies from the power supply are in the form ‘#AK\r’, or ‘#NAK\r’; this non-acknowledgment reply is generated when:

- the SY3634 system is in LOCAL mode;
- the module is still performing a ramp (it is necessary to wait for the power supply to end the previous ramp) or is performing a waveform;
- the module is OFF (it is necessary to turn the module ON first);
- the set value is out-of-range.

Examples:

MWH example with the system in LOCAL mode:

MWH:0FA2\r → #NAK\r

MWH example with the module ON:

MWH:0FA2\r → #AK\r

5.3.37 “MWI” Command

The ‘MWI’ command can be used to set the output current value and it is used when fast set-point changes are needed.

The use of this command is alternative to the MRM (Module RaMping): the power supply reaches the desired output current value just using the PID regulator parameters, without ramping with the pre-defined slew rate to the new set-point.

This command is usually needed when running feedback-related applications and for small changes in the output current.

The correct form format for this command is as follows:

MWI:value\r

where:

- *value* is the desired output current value [A].

Replies from the power supply are in the form ‘#AK\r’, or ‘#NAK\r’; this non-acknowledgment reply is generated, as it is for the MRM command, when:

- the set *value* is out-of-range (the maximum settable current value is user-defined and stored in EEPROM cell 4);
- the module is OFF (it is necessary to turn the module ON first);
- the module performing a ramp (it is necessary to wait for the power supply to end the previous ramp) or a waveform;
- the system is in LOCAL mode.

Examples:

MWI example with the module OFF:

MWI:-8.55679\r → ← #NAK\r

MWI example with the module ON and already regulating:

MWI:13.50\r → ← #AK\r

It is very important to notice that, even if the module is ON and regulating the output current correctly, an MWI command can generate a “Crowbar” intervention and a consequent fault if the current change step is too large, especially for large inductive loads; this is due to the large di/dt that generates voltage peaks.

5.4 IP Address Configuration

The easiest way to configure the A36xxBS module IP address is to set it by the Connectivity menu on the unit LOCAL control – i.e. encoder and display (see section 4.2.6 for further details).

In other cases, when accessibility to the power supply by the user is not possible, there is the need to configure the IP address REMOTELY.

The situations can be mainly two:

- the actual power supply IP address is known by the user. In these case the new IP address configuration can be performed with one of the two following methods:
 - by using the SIP command (see section 5.3.27 for further details);
 - via a basic Telnet connection.
- the actual power supply IP address is NOT known by the user. In these case the new IP address configuration can be performed by using the DeviceInstaller® software.

An overview of the procedures to be followed using the just cited methods is herein presented.

5.4.1 IP Address configuration - SIP command

If the power supply IP address is known by the user, it is possible to configure the new IP address by using the SIP command.

This operation must be performed when:

- the SY3634 system is in REMOTE mode;
- the A36xxBS module is OFF (it is necessary to disable the channel with the MOFF command first for safety purposes);
- the passed IP address is correct.

If one of the three just cited conditions is not satisfied, the power supply will not operate any change in its IP address and will reply with a non-acknowledgment command.

The format used to set the IP address must be as follows:

SIP:ip_addr\r

If the power supply actual IP address is known and there's an active connection to the module, the configuration can be performed, for example, as follows.

SIP:192.168.0.55\r →

← #AK\r

Obviously, after the new IP is set, the Ethernet module will reset and the connection to the host PC (or device) will be lost. A new connection must be established to the new IP address - e.g. 192.168.0.55.

5.4.2 IP Address configuration - TELNET connection

If the power supply IP address is known by the user, it is also possible to configure the new IP address by using a simple TELNET connection.

The TELNET connection must be established to **port 9999** of the Ethernet device of the power supply module.

Please carefully follow the instructions in order to correctly set/change the IP address of the A36xxBS module:

- establish a TELNET connection to port 9999 of the module IP address - e.g. 192.168.0.10;

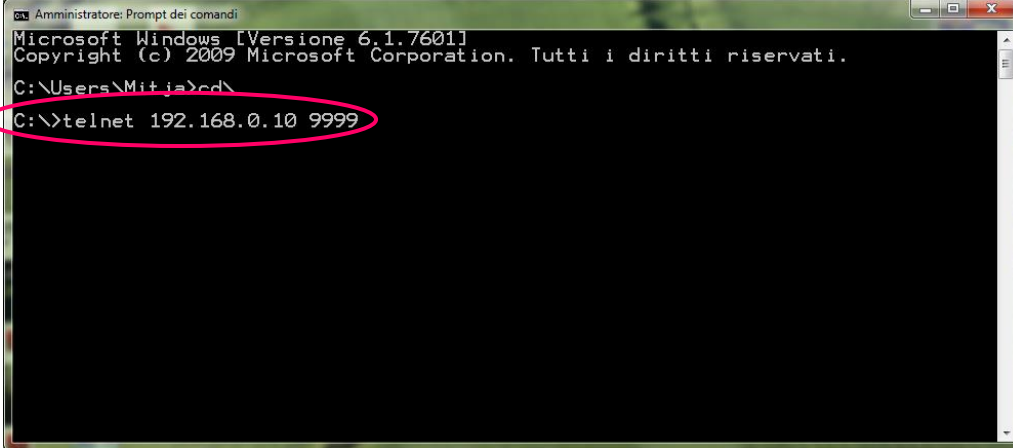

```
Amministratore: Prompt dei comandi
Microsoft Windows [Versione 6.1.7601]
Copyright (c) 2009 Microsoft Corporation. Tutti i diritti riservati.
C:\Users\Mitja>cd\
C:\>telnet 192.168.0.10 9999
```

- now press Enter on the prompt to enter configuration menu;

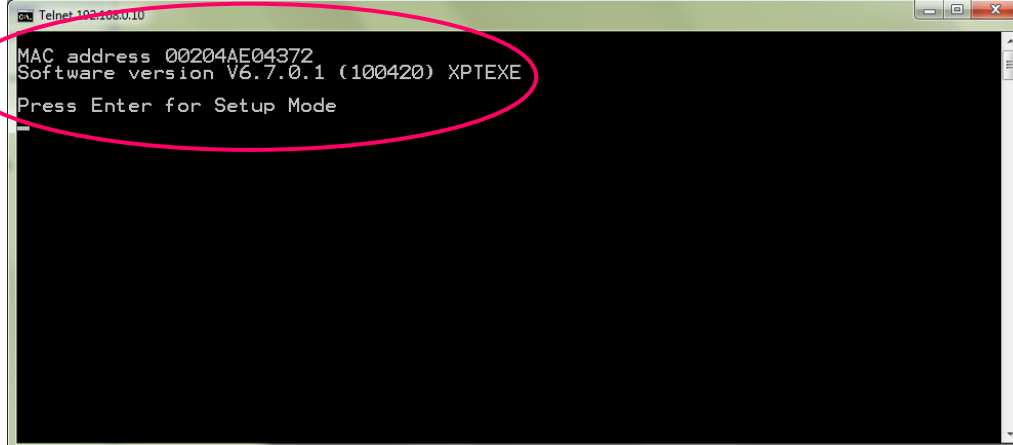

```
Telnet:192.168.0.10
MAC address 00204AE04372
Software version V6.7.0.1 (100420) XPTXE
Press Enter for Setup Mode
```

- on the device Telnet-based menu first select the “Server” option by inserting “0” and by pressing Enter on the prompt.

```

Telnet 192.168.0.10
Min. notification interval: 1 s
Re-notification interval : 0 s

- Trigger 3
Serial trigger input: disabled
Channel: 1
Match: 00,00
Trigger input1: X
Trigger input2: X
Trigger input3: X
Message :
Priority: L
Min. notification interval: 1 s
Re-notification interval : 0 s

Change Setup:
0 Server
1 Channel 1
2 E-mail
3 Expert
4 Security
5 Defaults
6 Exit without save
7 Save and exit
Your choice ? 0

```

- when asked for the "IP Address" please enter the desired new IP address for the power supply. Please note that the IP address must be entered as 4 three-digit number - e.g. 192.168.0.111;

```

Telnet 192.168.0.10
- Trigger 3
Serial trigger input: disabled
Channel: 1
Match: 00,00
Trigger input1: X
Trigger input2: X
Trigger input3: X
Message :
Priority: L
Min. notification interval: 1 s
Re-notification interval : 0 s

Change Setup:
0 Server
1 Channel 1
2 E-mail
3 Expert
4 Security
5 Defaults
6 Exit without save
7 Save and exit
Your choice ? 0
IP Address : (192) 192.(168) 168.(000) 0.(010) 111

```

- Press the Enter key until reaching the "Your choice" screen again. Now insert "9" - i.e. Save and exit - and press Enter again.

```

Telnet 192.168.0.10
0 Server
1 Channel 1
2 E-mail
3 Expert
4 Security
5 Defaults
6 Exit without save
7 Save and exit
Your choice ? 0
IP Address : (192) 192.(168) 168.(000) 0.(010) 111
Set Gateway IP Address (N) ?
Netmask: Number of Bits for Host Part (0=default) (8)
Set DNS Server IP addr (N) ?
Change Telnet/Web Manager password (N) ?

Change Setup:
0 Server
1 Channel 1
2 E-mail
3 Expert
4 Security
5 Defaults
6 Exit without save
7 Save and exit
Your choice ? 9

```

The device should now reboot in order for the changes to take effect.

5.4.3 IP Address configuration - DeviceInstaller®

If the power supply IP address is not known by the user and local access to the module is not possible, the best way to find out and to configure the module IP address is to use the DeviceInstaller® software.

The DeviceInstaller® software can be downloaded for free from the Lantronix website www.lantronix.com. The A36xxBS modules can be connected to a global LAN or point-to-point (recommended in order to obtain minimum delays, maximum speed performance and to avoid possible communication problems). Please note that for a point-to-point direct connection a twisted Ethernet cable must be used.

The next few steps must be followed in order to assign a new IP address to the “ETHERPiggy” module:

- Connect to the desired A36xxBS module with a twisted Ethernet cable;
- Verify that the “Link LED” on the RJ45 connector is turned on (amber for a 10Mbps connection or green for a 100Mbps connection);
- Launch the “DeviceInstaller” program;
- Select the XPort device where you want to change the IP address;

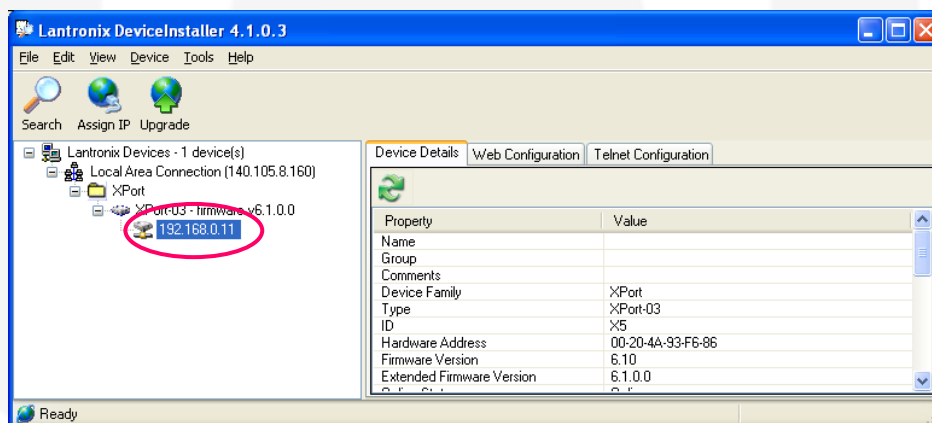

- Click on the “Assign IP” icon;

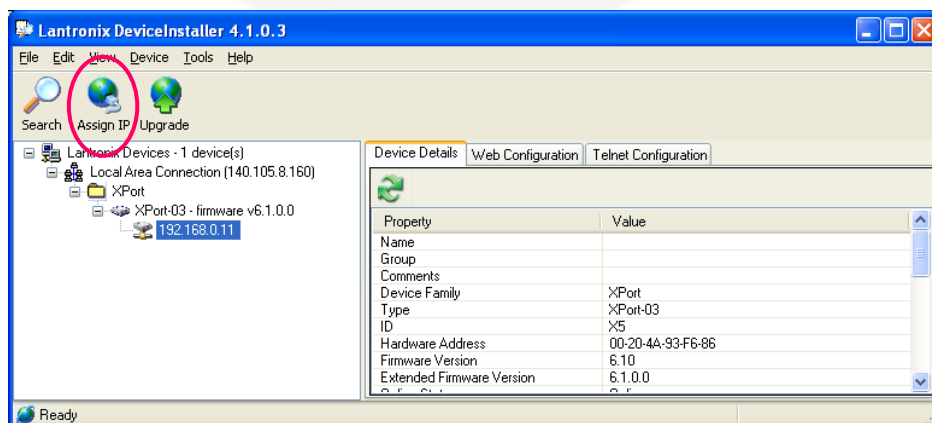

- Select “Assign a specific IP address” and then click “Next”;

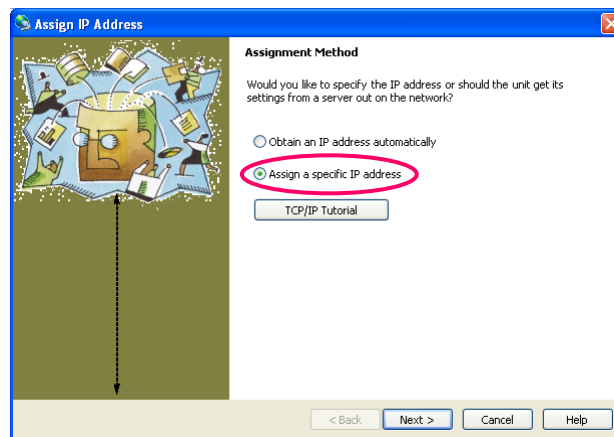

- Complete the “IP address” field and click on “Next”;

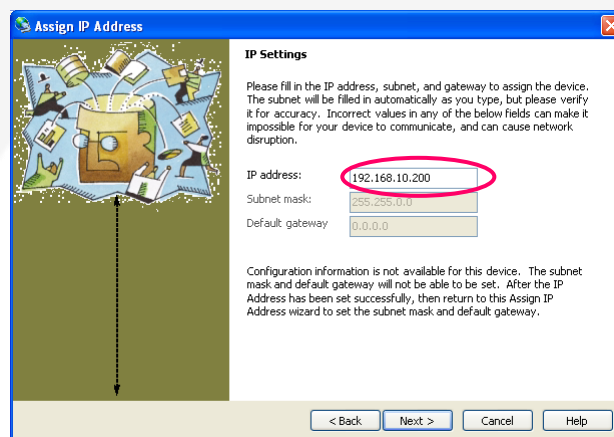

- Click on the “Assign” button;

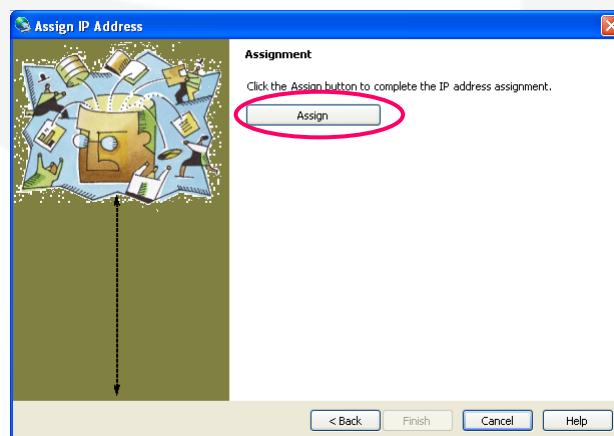

- Wait for the assignment procedure to end, and then click “Finish”.

The new module IP address should now be assigned and the success of the operation can be verified on the “DeviceInstaller” main window (if the window does not refresh, click on “Search”).

6. Technical Specifications

Technical Specifications for the SY3634 system crate, the A3636 auxiliary power supply and the A3605BS, A3610BS, A3612BS, A3620BS, A3630BS DC-DC modules are here presented.

A3636 – Auxiliary Power Supply	
Input voltage	85 – 265V(AC) 50 – 60Hz
Input current	0.65A
Inrush current	28A
Output voltage	12V
Output current	8.5A
Load regulation	100mV
Line regulation	50mV
Efficiency	83 – 86 %

	A3605BS	A3610BS	A3612BS	A3620BS	A3630BS
Output current range	± 5 A	± 10 A	± 12 A	± 20 A	± 30 A
Output voltage range	± 20 V	± 20 V	± 20 V	± 20 V	± 20 V
Maximum output power	100 W	200 W	240 W	400 W	600 W
Current setting resolution	160 µA	320 µA	390 µA	640 µA	950 µA
Output current readback	20 bit				
Output voltage readback	20 bit				
Output current ripple*	30 ppm / FS				
Output current stability	50 ppm / FS				
DC/DC efficiency	90%	92%	92%	94%	95%

Switching Frequency		104 kHz
Closed Loop Bandwidth		1.5 kHz
Accuracy		0.05%
External Interlocks/States		8 Inputs: user-configurable "dry" contacts 3 Outputs: relay-type (2 magnetic + 1 solid-state)
Internal Interlocks		DC Link Under-Voltage MOSFETs Over-Temperature Shunt Over-Temperature Over-Current Over-Voltage Earth Fault Current Regulation Fault Excessive Current Ripple
Hardware protections		Input Fuses Earth Fuse Over-Voltage
Auxiliary ADC Read-Backs (16 bit resolution)		DC Link Voltage Ground Leakage Current MOSFETs Temperature Shunt Temperature
Cooling		On-Module Self-Regulated Fans
Drivers		EPICS / TANGO
Connection		Ethernet 10/100 Mbits
Extra-Features		Hot-Swap Point-by-Point Current Waveform Loading User-definable interlock thresholds, active levels and timings DSP and FPGA Firmware Remote Updates
Dimensions		18 TE 19" wide - 3U high Euro-mechanics rack
Input Voltage		90/260 V(AC) (47-63 Hz) and 24 V(DC)
Local Control / Monitor		Graphic Color Display and Encoder 6 LEDs

* on 1 mH load

Annex A - Output Connectors

Montageanleitung Han[®] Q 2/0 Assembly Manual Han[®] Q 2/0



**Sicherheitshinweis für nicht angeschlossene Kontakte:
Alle Kontakte in Uhrzeigerichtung mit Innensechskant
SW2 maximal anziehen.**

**Security Note, for not used contacts:
Please screw tightly all contacts clockwise with a
hexagonal screwdriver, wrench size 2.**

1. Kodierstifte 09120009922 in Stift- und Buchseneinsatz einsetzen
(optional)

*Insert coding pins 09120009922 into male and female insert
(optional)*

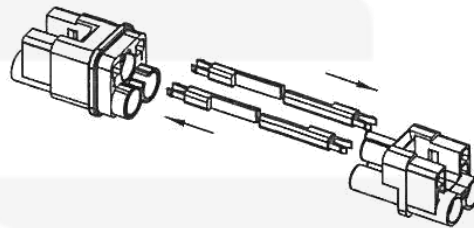

2. Kabelmantel entfernen und Litzen abisolieren

Strip cable and stranded wires

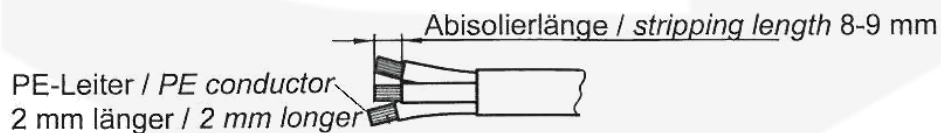

3. Kabel durch Gehäuse (und Kabelverschraubung) einführen

Push cable through the cable gland and into the hood/housing

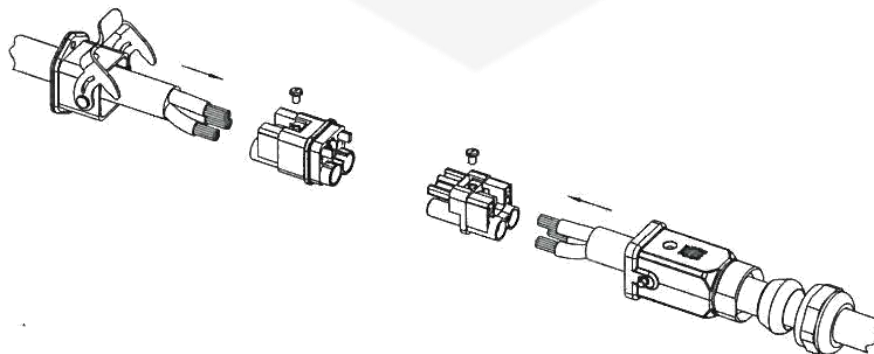

4. Litzen in Isolierkörper einführen und mit Innensechskant SW 2 mit 1,8 Nm Drehmoment anziehen

Push the stranded wires into the insert and fix with a hexagonal screwdriver to a torque of 1.8 Nm

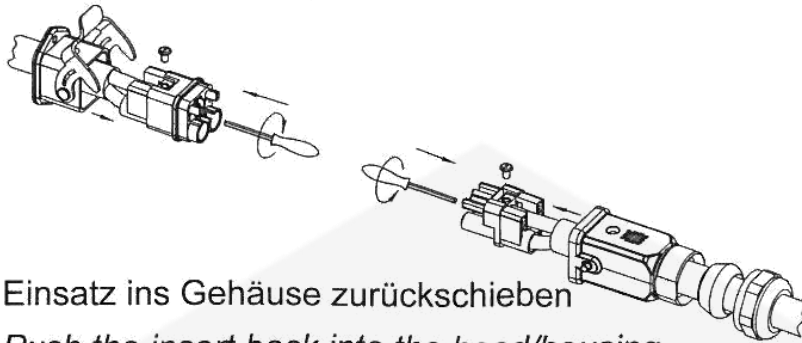

5. Einsatz ins Gehäuse zurückschieben

Push the insert back into the hood/housing

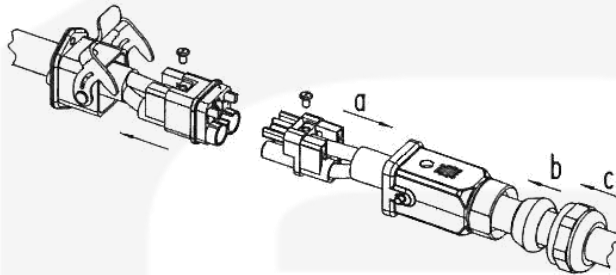

6. Verriegelungsschraube mit 0,5 Nm Drehmoment festziehen

Tighten locking screw to a torque of 0.5 Nm

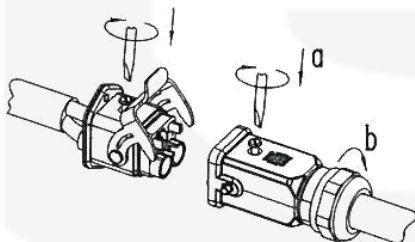

Sicherheitshinweis: Montage der Axialschraubkontakte nur mit Innensechskant SW 2!

Security Note: Assemble the axial screw contacts with a hexagonal screwdriver, wrench size 2, only!

HARTING Electric GmbH & Co. KG

Wilhelm-Harting-Straße 1 | D-32339 Espelkamp

Fon: +49 57 72 47-97100 | Fax: +49 57 72 47-124

Internet: www.HARTING.com

E-Mail: HARTING.Electric@HARTING.com

09 12 002 2651/99.01

Connections to the load must be carried out considering that the DC output connector pinout is presented in **Figure 24**:

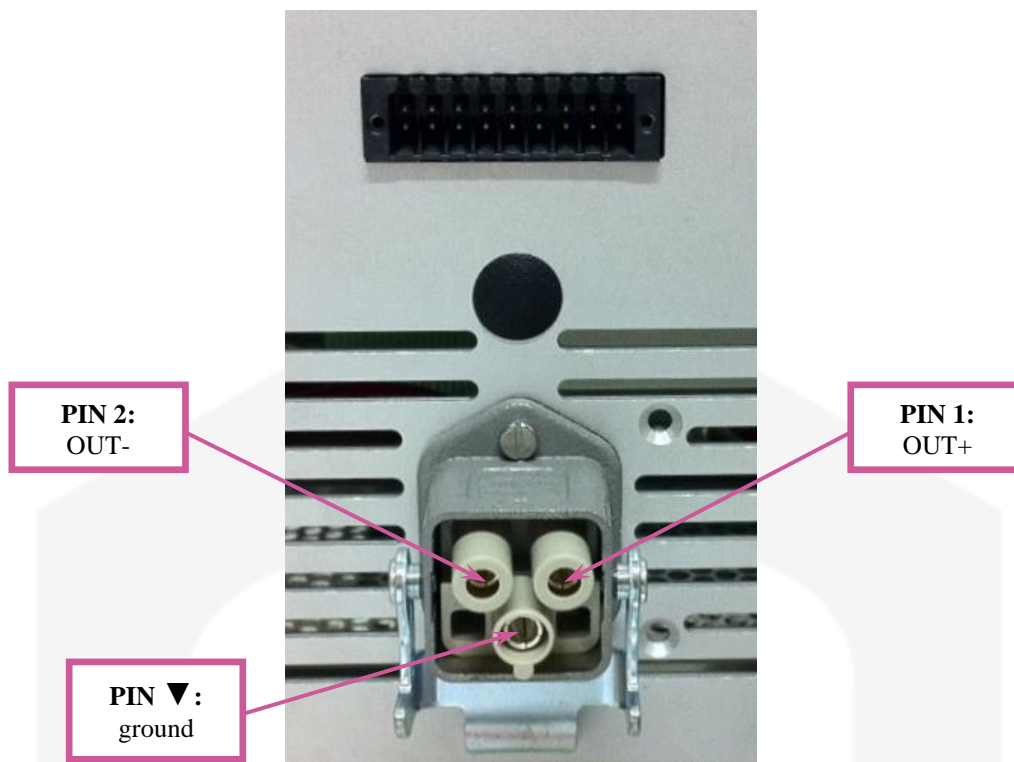

Figure 24: output connector pinout

The corresponding pinout is:

- **pin 1:** positive output terminal;
- **pin 2:** negative output terminal;
- **pin ▼:** ground terminal (not required).

Please note that the pin ▼, internally connected to ground, is not required for the correct power supply operation.