

QDS

Quench Detection System

**4-Channel Multi-Range Precision
Digital Quench Detection System**



User's Manual



All Rights Reserved
© CAEN ELS s.r.l.
Rev. 4 – February 2026



This product is **CE** & compliant.
UK
CA



CAEN ELS s.r.l.

Via Karl Ludwig Von Bruck 32– 34144 Trieste (TS)

Italy

Mail: info@caenels.com

Web: www.caenels.com

Registered office:

via Karl Ludwig Von Bruck 32– 34144 Trieste (TS) - Italy

Table Of Contents

1. INTRODUCTION.....	6
1.1 THE QDS QUENCH DETECTION SYSTEM.....	6
1.2 THE QDS AT A GLANCE.....	7
1.3 FEATURES	9
1.4 SIGNAL PROCESSING.....	10
1.5 QUENCH DETECTION.....	11
1.5.1 Absolute Quench Thresholds	11
1.5.2 Relative Quench Thresholds	11
1.6 DATA FORMAT.....	11
1.7 OFFSET CALIBRATION.....	12
1.7.1 User Defined Calibration	12
1.8 ORDERING CODES.....	13
2. SOFTWARE COMMANDS	14
2.1 COMMAND SYNTAX	14
2.2 COMMAND TABLE SUMMARY	15
3. ETHERNET COMMUNICATION	16
3.1 IP ADDRESS ASSIGNMENT	16
3.2 CAENELs DEVICE MANAGER	17
3.2.1 Searching for connected devices.....	17
3.2.2 Device Configuration.....	19
3.2.3 Firmware Upgrade	20
4. I/O CONNECTORS.....	22
4.1 POWER CONNECTOR	22
4.2 TRIGGERS CONNECTOR.....	23
4.3 INTERLOCK AND GENERAL I/O CONNECTOR.....	23
4.4 ETHERNET AND SFP CONNECTOR	25
4.5 INPUT TWIN BNC (TWINAX) CONNECTORS.....	25
4.6 INTERLOCKS/STATUS CONNECTOR	27
4.6.1 Persistent Switch.....	28
4.6.2 Magnetic Relay Output	28
4.6.3 External Interlocks.....	29
5. TECHNICAL SPECIFICATIONS	30
5.1 EQUIVALENT INPUT NOISE.....	31
6. MECHANICAL DIMENSIONS.....	32
7. QDS POWER SUPPLY.....	34
7.1 THE PS1112S LINEAR POWER SUPPLY	34
7.2 THE PS1112S AT A GLANCE	34
7.3 TECHNICAL DATA	36
7.4 I/O CONNECTORS.....	37
7.4.1 AC Line Input Connector	37
7.4.2 Output	37

7.4.3	<i>Status LED</i>	38
7.4.4	<i>Mechanical Fixing</i>	39
7.5	MOUNTING POSITION	39
7.6	TECHNICAL SPECIFICATIONS.....	41
8.	19”-2U MOUNTING CRATE - <i>OPTIONAL</i>	42
8.1	DESCRIPTION	42



Document Revision	Date	Comment
0.1	August 26 th , 2021	Document created
0.2	November 16 th , 2021	Fixed technical specifications
0.3	November 22 nd , 2022	Added UKCA compliance logo
0.4	February 9 th , 2023	Added DEVID Command
1	August 22 nd , 2024	Updated address and revision numbering
2	September 15 th , 2025	Fixed typo in technical specifications
3	December 1 st , 2025	Fixed typos, modified chapters 1.2, 2.0, 7.4.1 and added <code>LOGGER</code> command
4	February 11 st , 2026	Added suggested Twin-ax mating connector in Section 4.5



Safety information - Warnings

CAEN ELS will repair or replace any product within the guarantee period if the Guarantor declares that the product is defective due to workmanship or materials and has not been caused by mishandling, negligence on behalf of the User, accident or any abnormal conditions or operations.

Please read carefully the manual before operating any part of the instrument



Do NOT open the boxes

CAEN ELS s.r.l. declines all responsibility for damages or injuries caused by an improper use of the Modules due to negligence on behalf of the User. It is strongly recommended to read thoroughly this User's Manual before any kind of operation.

CAEN ELS s.r.l. reserves the right to change partially or entirely the contents of this Manual at any time and without giving any notice.

Disposal of the Product

The product must never be dumped in the Municipal Waste. Please check your local regulations for disposal of electronics products.



Read over the instruction manual carefully before using the instrument.
The following precautions should be strictly observed before using the QDS device:

WARNING

- Do not use this product in any manner not specified by the manufacturer. The protective features of this product may be impaired if it is used in a manner not specified in this manual.
- Do not use the device if it is damaged. Before you use the device, inspect the instrument for possible cracks or breaks before each use.
- Do not operate the device around explosives gas, vapor or dust.
- Always use the device with the cables provided.
- Turn off the device before establishing any connection.
- Do not operate the device with the cover removed or loosened.
- Do not install substitute parts or perform any unauthorized modification to the product.
- Return the product to the manufacturer for service and repair to ensure that safety features are maintained

CAUTION

- This instrument is designed for indoor use and in area with low condensation.

The following table shows the general environmental requirements for a correct operation of the instrument:

Environmental Conditions	Requirements
Operating Temperature	0°C to 40°C
Operating Humidity	30% to 85% RH (non-condensing)
Storage Temperature	-10°C to 60°C
Storage Humidity	5% to 90% RH (non-condensing)

1. Introduction

This chapter describes the general characteristics and main features of the QDS – Quench Detection System.

1.1 The QDS Quench Detection System

The QDS is a compact digital quench detection system and allows monitoring voltage levels on 4 channels with a 24-bit resolution, wide-bandwidth and wide input dynamic range in order to match all the different superconducting magnet needs.

The device is composed of a specially designed input stage for voltage sensing combined with analog signal conditioning and filtering stages making use of state-of-the-art electronics. This device can perform bipolar floating voltage measurements on 11 different ranges per channel with an internal sampling frequency of 100 kHz (for 4 channel at 24-bit resolution). Low temperature drifts, good linearity and very low noise levels enable users to perform very high-precision measurements.

The QDS is housed in a light, robust and extremely compact metallic box that can be placed at the user's convenience, in order to reduce cable lengths and minimize possible noise pick-up. It is specially suited for applications where multi-channel simultaneous acquisitions are required.

The QDS communication is guaranteed by a standard 10/100/1000 Mbps Ethernet TCP/IP protocol.

1.2 The QDS at a Glance

The QDS unit and its I/O connections can be easily seen in **Figure 1** (front) and in **Figure 2** (rear).

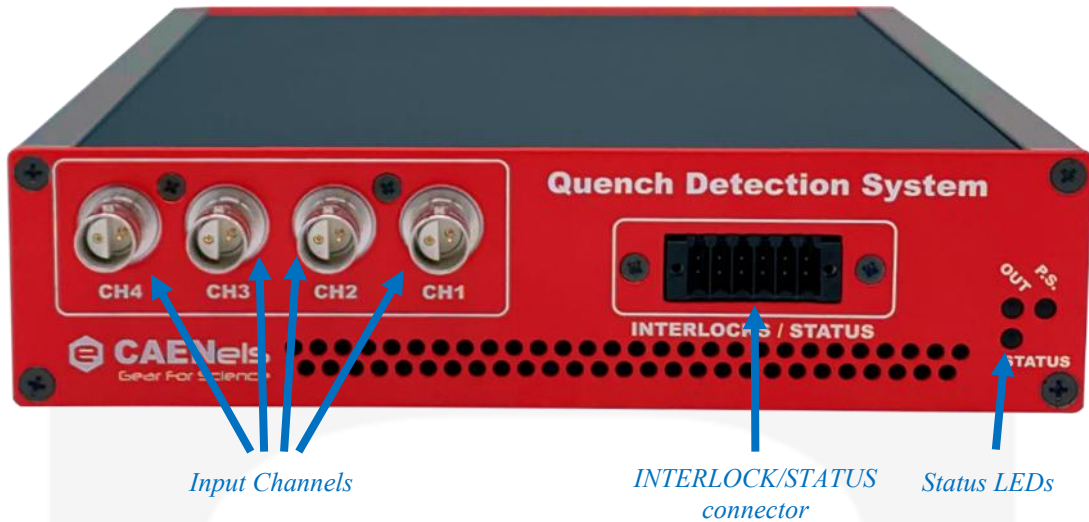

Figure 1: front view of a QDS unit

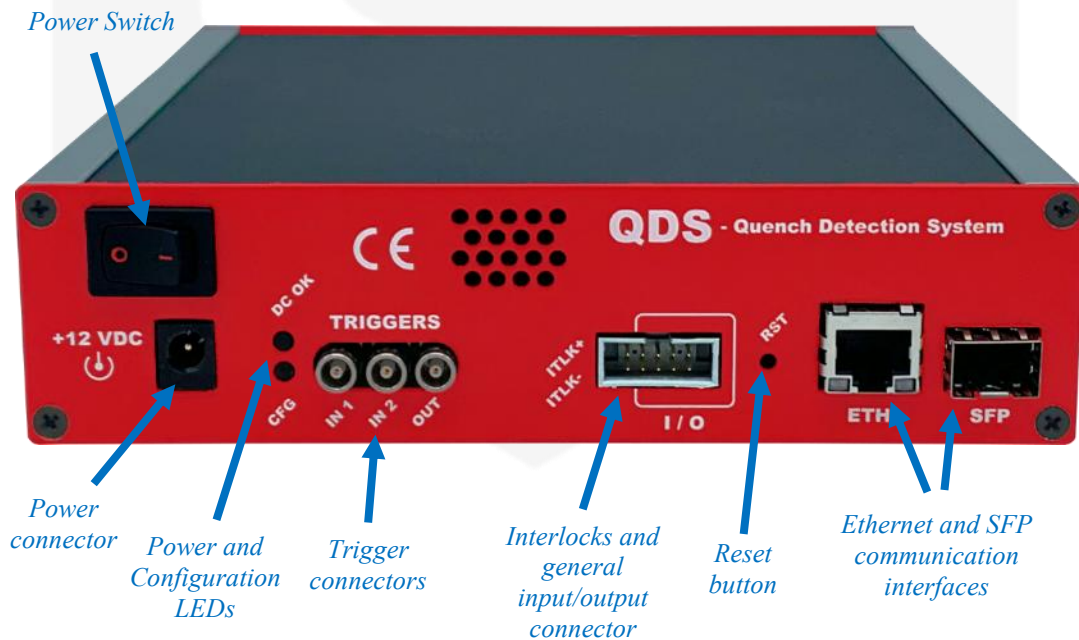

Figure 2: rear view of a QDS unit

On the front side of the QDS unit are placed four analog Twinax BNC current input connectors for input voltage measuring, various status LEDs and the INTERLOCKS/STATUS connector that has different status signals, separate 12-V and 24-V persistent switch power output and interlocks.

The OUT and the P.S. LEDs are used to signal the status of the output and of the persistent switch (P.S.) power. A blue “Status LED” is placed right under and it is used to signal the correct operation of the device. During normal operation of the QDS unit the “Status LED” is blinking with a frequency of 0.5 Hz – i.e. the LED changes its status every 2 seconds – on the other hand, if a fault condition arises, the LED blinks with a higher frequency of 2 Hz (the led changes its status every 0.5 seconds). During the boot phase of the QDS unit (which takes a few seconds) all these LEDs are turned on.

On the rear panel of the device are placed the power connector, the input power switch, two LEDs, LEMO connectors for I/O triggers, interlock and general I/O connector, a standard RJ45 Ethernet connector and an SFP connector.

The blue “CFG” led shows that the unit’s FPGA is correctly configured (in this case the LED is turned on). The green “DC OK” LED indicates that the internal sections are correctly powered.

The three LEMO connectors for I/O triggers are also placed on the rear panel. Please note that all 3 connectors – i.e. “IN 1”, “IN 2” and “OUT” – are reserved for future use.

The “Interlocks and general I/O connector” has the pinout configuration shown in **Figure 3**:

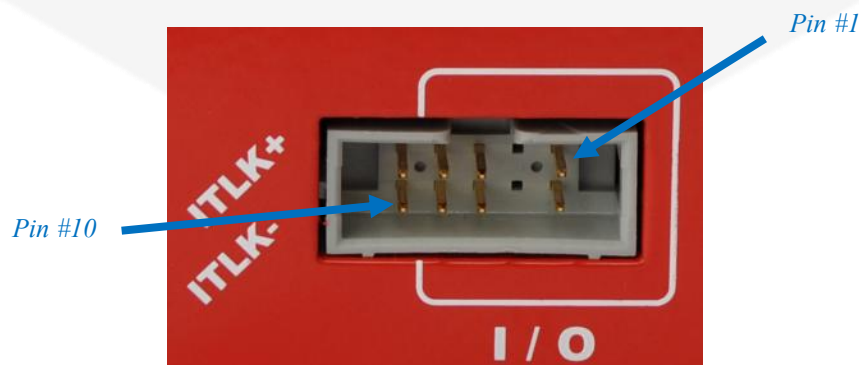

Figure 3: Interlock and general I/O connector

Pin #	Function
1-2	Reserved
3-4	Not present
5-8	General purpose I/O
9-10	External interlock

The external interlock pins can be used to detect an external event.

The General purpose I/O pins are not yet used and they are reserved for future use.

On the rear panel of the QDS there is a small hole that gives access to a reset button (“RST”), which can be used to reset the unit. Next to the reset button are placed a RJ45 Ethernet connector (“ETH”), which is used to communicate with the unit and a Small Form-factor Pluggable transceiver (“SFP”) which is currently not used.

1.3 Features

The QDS input stage is based on differential PGAs (Programmable Gain Amplifiers) cascaded with particular signal conditioning stages. Each channel is independently floating and can have a different range.

Eleven (11) standard measuring ranges are available for each channel independently; these range values with their corresponding resolution (LSB of the 24-bit Analog to Digital Converter) are shown in the following table:

	Full Scale	Resolution (LSB)
RNG 0	± 20 V	2.4 μ V
RNG 1	± 10 V	1.2 μ V
RNG 2	± 5 V	600 nV
RNG 3	± 2.5 V	300 nV
RNG 4	± 1.25 V	150 nV
RNG 5	± 625 mV	75 nV
RNG 6	± 312.5 mV	38 nV
RNG 7	± 156.25 mV	19 nV
RNG 8	± 78.125 mV	10 nV

RNG 9	± 39.0625 mV	5 nV
RNG 10	± 19.53125 mV	2.5 nV

A host PC is necessary in order to operate the QDS unit and properly set/check the desired parameters (e.g. range) and to acquire the converted data. Please refer to the Software commands chapter for a complete description of available commands, their purposes and their syntax.

Please note that the listed ranges are the theoretical ones and a tolerance of $\pm 2\%$ on the full-scale needs to be taken into account.

1.4 Signal Processing

Figure 4 shows the digital elaboration of the acquired data. The analog readings from the four channels are converted into the digital domain by high-speed high-precision ADCs running at 100 kHz.

The digital signals are then down-sampled to 1 kHz with an averaging filter (AVG block) to reduce the high frequency noise. The 1-kHz data are then elaborated with a moving average filter (MAVG block) with a user configurable time window.

The output of the moving average filter is the actual readout of the QDS device. Lastly, the output of the moving average filter is compared with a user-configurable threshold. Once a threshold is crossed the STATUS bit of the correspondent channel is raised (logic state “1”). The quench signal which drives the magnetic relay output (see 4.6.2 for more information) to signal that a quench has been detected is the logic “OR” of all the STATUS bits. This means that only one channel that crosses the threshold is required to generate a quench signal that drives the magnetic relay output. The STATUS register needs to be reset (logic state “0”) before going back to normal operation.

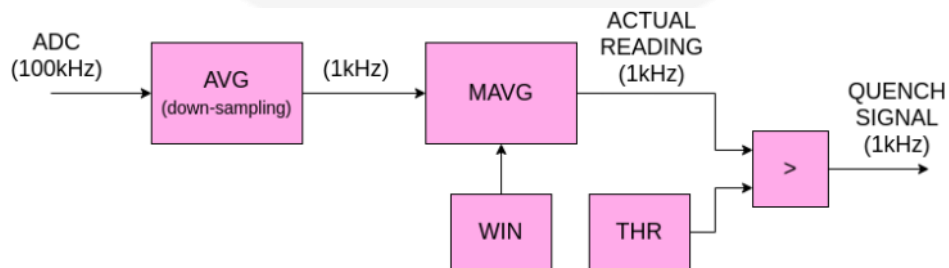

Figure 4: Signal processing block diagram

1.5 Quench Detection

The QDS system is a very flexible and configurable device to detect quenching in superconducting magnets. Up to 4 channels (taps) can be connected to its inputs and different thresholds can be set.

Thresholds can be set as differential values between different channels and/or as absolute channel voltage values.

1.5.1 Absolute Quench Thresholds

Up to four different quench thresholds can be set, one for each channel of the QDS unit (CH1, CH2, CH3 and CH4). Each channel can have a different threshold value. The absolute thresholds are intended as absolute values, meaning that if a threshold of 1 V is set, a quench signal is generated if the reading is $> +1V$ or $< -1V$.

1.5.2 Relative Quench Thresholds

The QDS system enables the user to set different threshold for each pair of channels:

- $|CH1-CH2|$ (also referred to as CH12);
- $|CH1-CH3|$ (also referred to as CH13);
- $|CH1-CH4|$ (also referred to as CH14);
- $|CH2-CH3|$ (also referred to as CH23);
- $|CH2-CH4|$ (also referred to as CH24);
- $|CH3-CH4|$ (also referred to as CH34).

The relative thresholds are positive values.

1.6 Data Format

Acquired data from the QDS unit can be configured to be transmitted in two different formats, depending on status of ASCII Command. ASCII commands allow users to choose between ASCII data format, which is readable by humans, and raw floating-point numbers in double precision format (IEEE 754) that are faster to process,

they are more accurate and have less overhead during the transmission. For more information about the data transfer see the Acquisition Commands descriptions.

1.7 Offset Calibration

The QDS device is already factory-calibrated during the production process. However, user can perform an additional calibration – i.e. User Defined Calibration – perhaps nulling application specific.

1.7.1 User Defined Calibration

As previously noted, the QDS device has the capability of handling user-defined linear calibration parameters on each channel in order to obtain the desired response from the unit.

The equivalent voltage read, by considering the user calibration, it is computed as follows:

$$V_{READ} = V_{raw} + Offset_{UD}$$

where:

- V_{READ} is the user-calibrated voltage read from the single channel [V];
- V_{raw} is the raw voltage read of the device [V];
- $Offset_{UD}$ is the user-defined offset value [V].

The user can enable or disable (as it can also read/write) this calibration values with the specific USRCORR Command or from the “*QDS-Viewer*” interface. These calibration values can be stored internally in a non-volatile memory so that it is possible to recall them at any time, also after a power-cycle of the device (see the “*Quench Detection System Commands Reference Manual*” for more information on how to save and load the User Correction parameters)

1.8 Ordering Codes

The QDS unit described in this manual has the following ordering codes:

Ordering Code	Ranges	BW	Description
QDS4CHXAAAAA	± 20 V (max) ± 20 mV (min)	1 kHz	<i>4-channel Quench Detection System with Persistent Switch Heater - Ethernet-controlled</i>

2. Software Commands

This chapter summarizes the main commands available on the QDS system. Refer to the “*Quench Detection System Commands Reference Manual*” for a more detailed description. For more information about the Ethernet settings see the Ethernet Communication chapter.

QDS also provides dedicated software, “*QDS-Viewer*”, which greatly simplifies the user interface. Refer to the “*QDS_UserInterfaceManual*” for a more detailed description.

2.1 Command Syntax

All numbers are transmitted in ASCII data format. All commands are terminated with `\r\n` characters.

“*Write*” commands respond with **ACK** or with **NAK:<error_code>**. A detailed description of the error codes is reported in “*Quench Detection System Commands Reference Manual*”. “*Read*” commands respond with an echo.

The commands are formatted as follows:

<COMMAND>

or:

<COMMAND>:<OPTION>

or:

<COMMAND>:<PARAMETER>:<OPTION>

2.2 Command Table Summary

Command	Purpose	Parameters
VER	Reads device model and version	
HELP	Reads commands list	
TEMP	Reads internal system temperature	
IFCONFIG	Reads interface configuration and statistics	
GET	Reads single or all channels	:<channel>:? :?
RNG	Writes/Reads single or all channels range	:<channel>:<value> :<channel>:? :<value> :?
WIN	Writes/Reads single or all channels time windows	:<channel>:<value> :<channel>:? :<value> :?
THR	Writes/Reads single or all channels thresholds	:<channel>:<value> :<channel>:? :<value> :?
ENA	Enables/Disables channel	:<channel>:<value> :<channel>:? :<value> :?
STR	Reads/Resets status	:RESET :?
PRS	Sets/Clears persistent switch	:<value> :?
USRCORR	Enables/Disables or writes/reads user correction or store values	:<state> :? :RNG<r >CH<ch>OFFS:<v > :RNG<r >CH<ch>OFFS:? :SAVE
FLS	Reads channel/range full scale	:<channel>:? :CH:? :<range>:? :RNG:?
DFLT	Restores default parameters.	
SAVE	Saves configuration in the EEPROM	
LOAD	Configuration to load on start-up (default or user parameters)	:? :<setting>
DEVID	Query the Device ID Set a new Device ID (4 characters)	:? :SAVE:<dev id>
LOGGER	Enables/Disables Logger Sets Logger frequency	:<value> :? :FREQ:<freq> :FREQ:?

3. Ethernet Communication

The communication with the QDS unit is based on a 10/100/1000 Mbps Ethernet link. The suggested connection speeds are 100 Mbps or 1 Gbps since the 10 Mbps connection is limiting the data rate.

Factory network configuration and “CAENels Device Manager” software are described in the following sections.

3.1 IP Address Assignment

The device is shipped with default IP address, subnet mask, gateway and TCP-IP communication port:

Parameter	Factory value
<i>IP address</i>	192.168.0.10
<i>Subnet mask</i>	255.255.255.0
<i>Gateway</i>	192.168.0.1
<i>TCP/IP port</i>	10001

Even if the QDS device can be connected to a LAN network, a point-to-point Ethernet connection is strongly recommended in order to obtain minimum delay, maximum data rate performance and to avoid possible communication problems – i.e. increasing communication reliability. This implies that the host PC and the QDS should reside on the same Ethernet subnet.



When using a point-to-point connection, it is not necessary to use a twisted cable because the used Ethernet link has an automatic detection of the communication direction – i.e. auto-sensing.

To change the device network setup, it is necessary to use the “*CAENels Device Manager*” software that can be downloaded from the CAENels website <http://support.caenels.com/caenels/repos/apps/>. A brief description of this software is given in next section.

3.2 CAENels Device manager

The software “*CAENels Device manager*” can be used to search for all the QDS devices connected to the local network and to configure them. This software also allows setting network configuration of the connected devices and to update their firmware.

“*CAENels Device manager*” is available for Windows and Linux platforms and the system requirements are hereafter listed:

-  Windows minimum system requirements:
 - Windows® 7 or newer
 - x86 or amd64
 - ~150 MB available HD space
 - Ethernet network card
-  Linux minimum system requirements:
 - Linux kernel 2.2.x or newer
 - Intel® or equivalent processor
 - ~150 MB available HD space
 - Ethernet network card
- macOS:
 - Minimum OS X version supported is OS X 10.9
 - ~150 MB available HD space
 - Ethernet network card

3.2.1 Searching for connected devices

Please follow the next steps in order to search for the QDS devices connected to the local network:

- connect the host PC and the QDS directly with an Ethernet cable (or through a network);

- verify that the “*Link LED*” on the RJ45 connector is turned on (amber for a 1 Gbps connection as shown in **Figure 4** or green for a 100 Mbps connection). The LED is turned off if the Ethernet cable is not connected or if the speed of connection is limited to 10 Mbps (in this last case the device is working correctly even if it is not recommended to use a slow connection since the data transfer rate is limited);

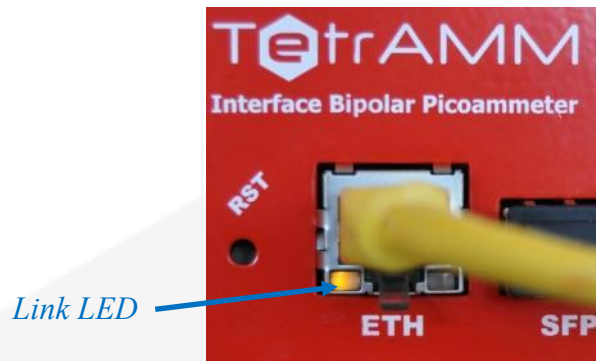

Figure 5: Ethernet Link

- connect the QDS to the AC/DC power supply unit and switch it on;
- install and launch the “*CAENels Device manager*” software;
- perform a scan to discover the connected QDS devices by clicking the “*Scan*” button as indicated in **Figure 5**. If there are multiple available networks it is possible to select the network/networks to be scanned in the “*Selected network interfaces*” window available under the “*Options*” menu. All the information about the selected devices is shown in the right side of the main window.

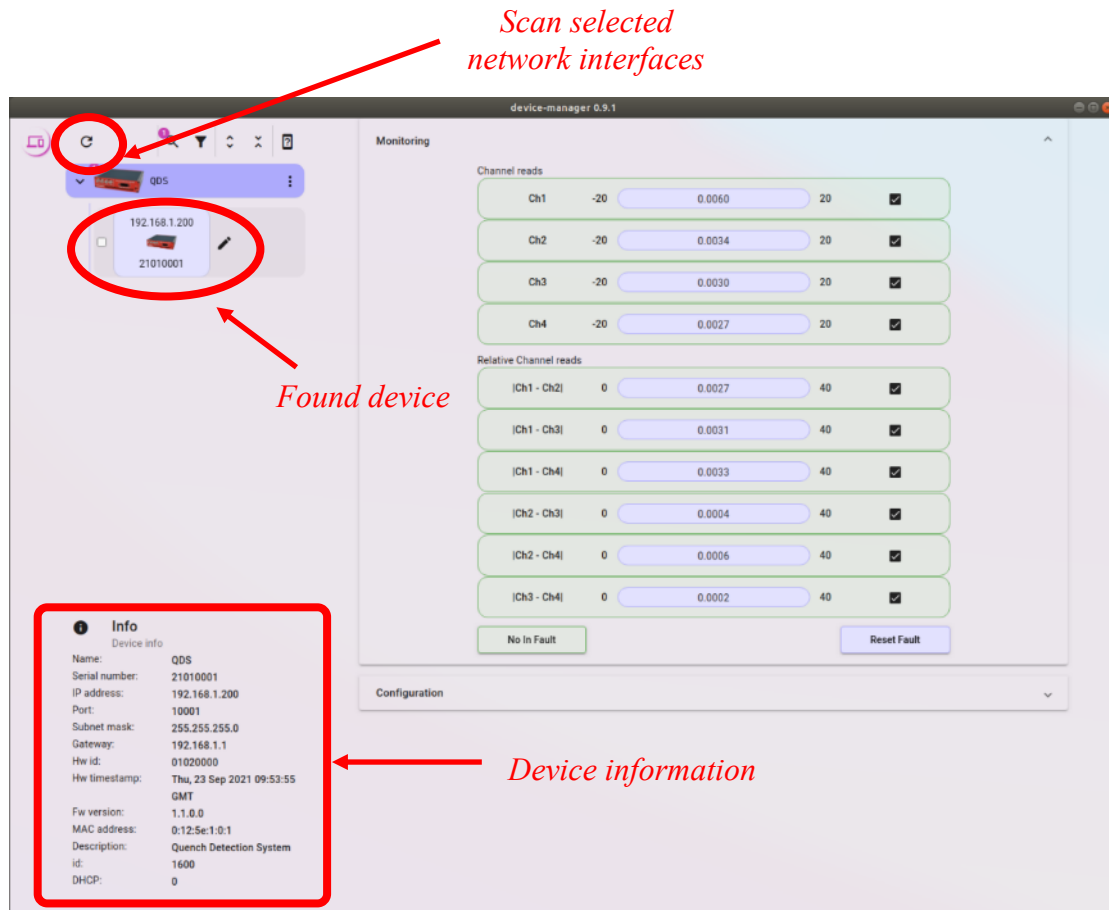

Figure 6: Main interface

If you have a firewall enabled on your router or on your computer, please make sure that the firewall is not preventing communication between your computer and the QDS device.

The “CAENels Device manager” uses **UDP port 30719** to find the device, so make sure that the UDP traffic is allowed in both directions on that port.

3.2.2 Device Configuration

It is possible to change the Network configuration of the found devices. In order to set the Network configuration, it is necessary to select the desired device and to click on the “Change device configuration” button in the main window as shown in **Figure 6**. The configurable Network options are:

- Device IP address;
- TCP/IP communication port;
- Subnet mask;

➤ Gateway.

To apply the changes on the device configuration it is necessary to edit the corresponding fields and then to click on the “Save” button. A screenshot of a sample device configuration is shown in the following picture:

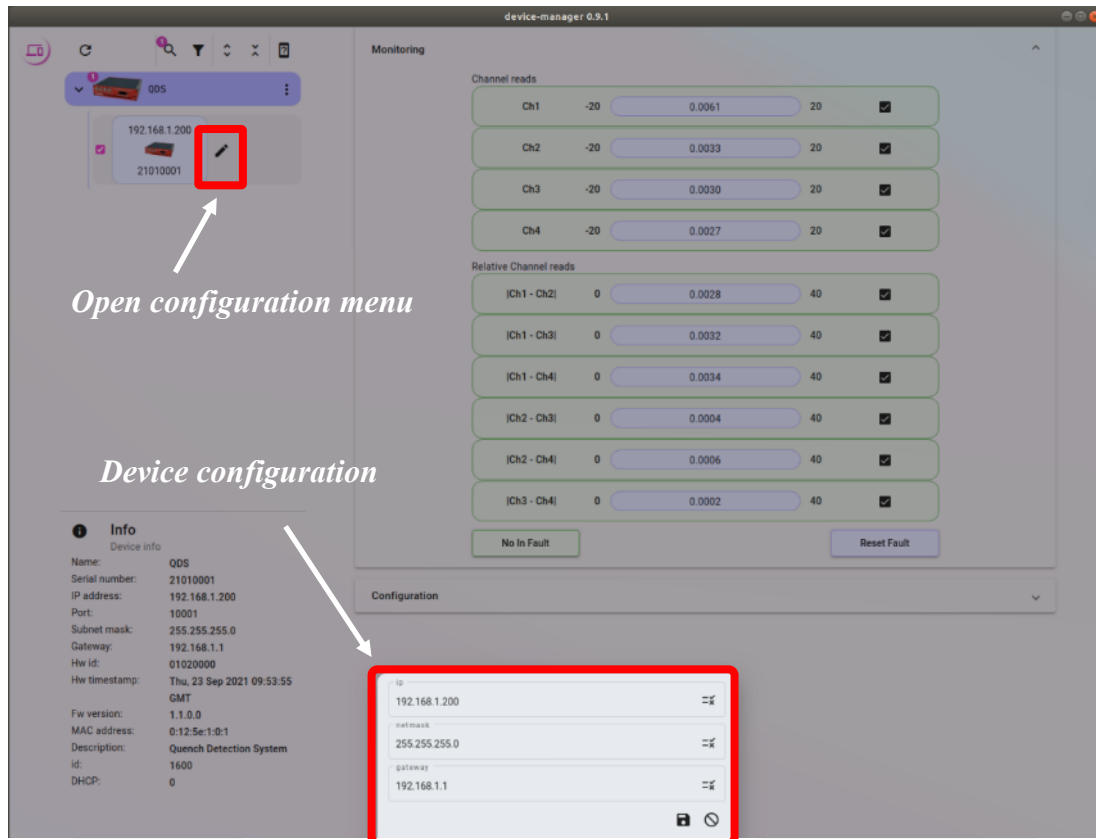

Figure 7: Change device configuration

3.2.3 Firmware Upgrade

“CAENels Device manager” software also allows remotely updating the firmware of the QDS devices.

In order to perform the update, select the desired device at first by clicking on the checkbox (as reported in **Figure 7**). Open the “Settings” menu by clicking on the three dots and finally click on the “Upgrade”, as shown **Figure 7**.

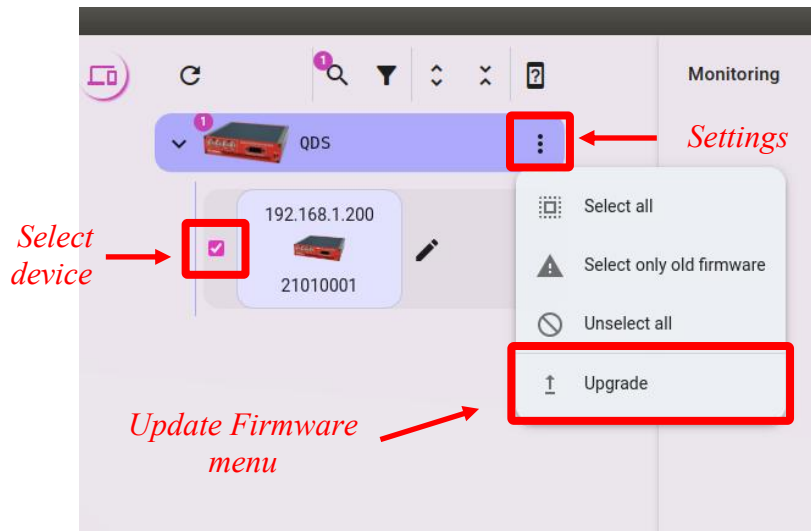

Figure 8: Update firmware menu

The new opened window (**Figure 8**) allows to select the new firmware file (*Flash file - *.flash*). **Disconnect all the QDS input channels during the update procedure.** Once the flash file has been selected (“Plus” button) it is possible to start the firmware update by clicking the “Play” button.

The firmware update task will take a few minutes. A screenshot of the update menu is shown hereafter:

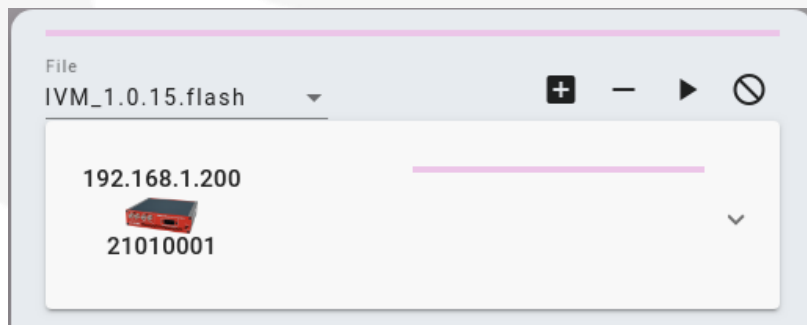

Figure 9: Update device

4. I/O Connectors

This chapter describes the I/O connectors present on the device front and rear panels, their corresponding pinout and each signal functionality.

4.1 Power Connector

The input power connector is a standard male locking jack socket. The input voltage is rated at +12 V ($\pm 3\%$) with a maximum input current of 1 A.

The input ON/OFF switch is placed above the input power connector which allows turning ON or OFF the device. The used connector is shown in **Figure 8**:

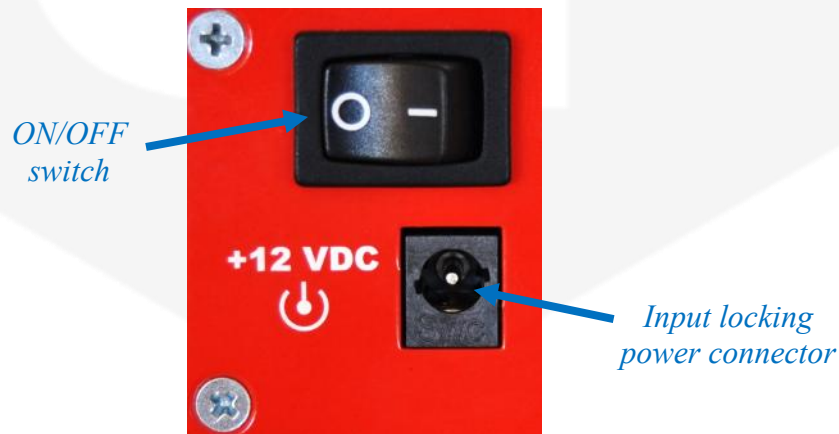

Figure 10: Power connector and switch

4.2 Triggers Connector

The QDS device has two input and one output trigger signals on LEMO coaxial connectors. These input/output connectors are called “Triggers” and are placed on the rear panel of the device as shown in **Figure 9**:

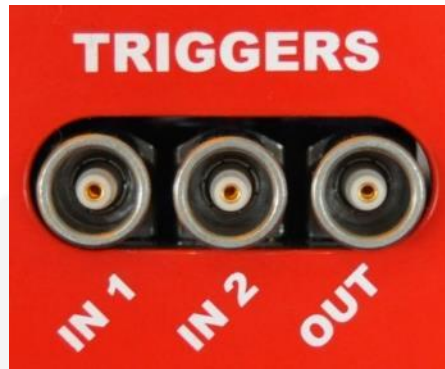

Figure 11: “Triggers” connectors on rear panel

PLEASE NOTE THAT THESE CONNECTORS ARE RESERVED FOR FUTURE USE AND NO FUNCTIONALITY IS IMPLEMENTED AT THE MOMENT.

4.3 Interlock and General I/O Connector

The “Interlocks and general I/O” connector, that has the pinout configuration described in **Figure 10**, is present on the rear panel of the QDS unit:

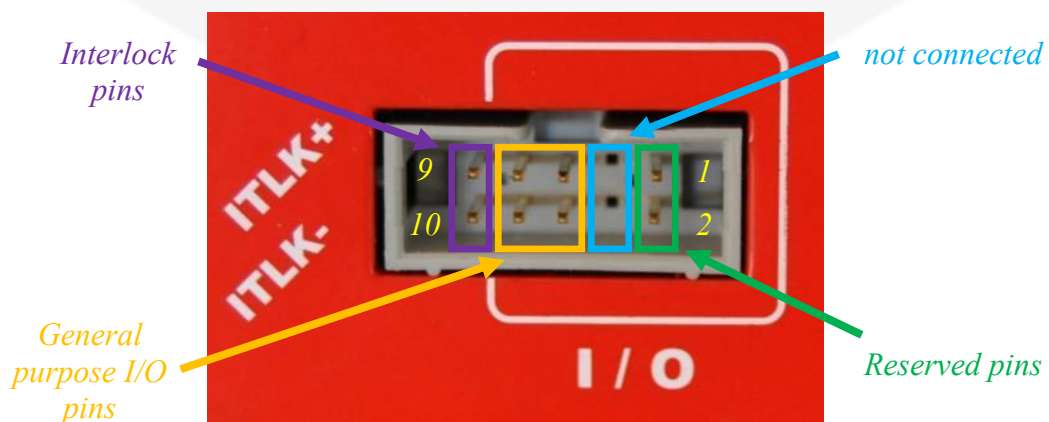

Figure 12: Interlock and I/O connector

The pin functions are summarized in the next table:

Pin #	Function
1-2	Reserved pins
3-4	<i>not connected</i>
5-8	General purpose I/O pins
9-10	External interlock pins

The “*External interlock pins*” (pins 9-10) can be used to detect an external signal that can be used to trigger additional functionalities. The interlock pins are galvanically isolated from ground.

Positive voltage must be applied to “ITLK+” and negative voltage to “ITLK-“, the maximum voltage that can be applied to the interlock “ITLK+” terminal is rated at +24V (the minimum signal that guarantees the tripping of this interlock is rated at +3V); the maximum reverse voltage that this interlock can sustain is rated at -5.5V.

An equivalent circuit is presented below in **Figure 13**:

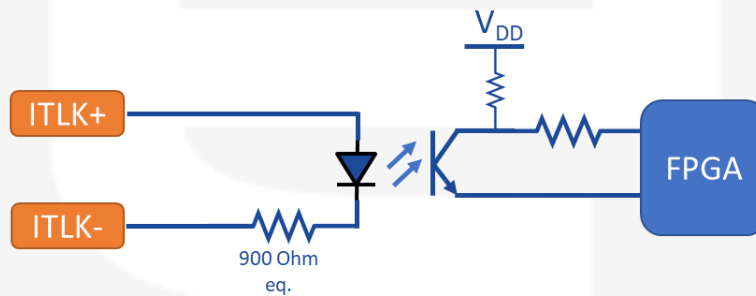

Figure 13: Interlock equivalent circuit

PLEASE NOTE THAT THE “EXTERNAL INTERLOCK PINS” ARE RESERVED FOR FUTURE USE AND NO FUNCTIONALITY IS IMPLEMENTED AT THE MOMENT.

The “*General purpose I/O pins*” (pins 5-8) are connected to the internal digital section and they are reserved for future system updates.

The “*not connected pins*” (pins 3-4) are not present or if present, they are not connected to the internal digital system.

The “*Reserved pins*” (pins 1-2) are connected to the internal digital section and are reserved for internal use, so they must NOT be connected.

4.4 Ethernet and SFP connector

On the rear side of the QDS unit there are also a RJ45 Ethernet connector and a small form-factor pluggable (SFP) slot as indicated in **Figure 14**:

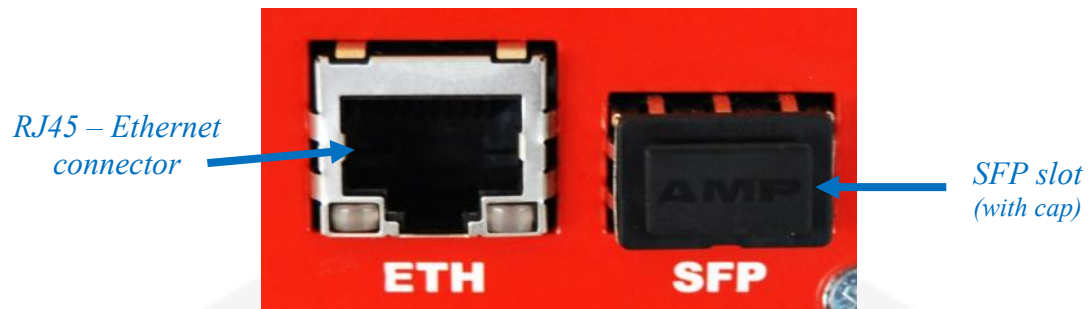

Figure 14: Ethernet and SFP connections

The RJ45 Ethernet slot is used to communicate with QDS unit. The connector is linked to a true 10/100/1000 Mbps physical device. For more information about the Ethernet communication see the Ethernet Communication section.

THE SFP CONNECTOR IS NOT YET USED FOR THE QDS AND IT IS RESERVED FOR FUTURE IMPLEMENTATIONS.

4.5 Input Twin BNC (TWINAX) connectors

The four TWINAX BNC connectors (Bayonet Neill-Concelman) on the front panel of the QDS unit are used to measure the different voltages.

Channel incremental numbering, as can be seen in **Figure 15**, is right-to-left (CH1 is the one the right while CH4 is the one on the left):



Figure 15: TWIN BNC input connectors

The pinout for the TWIN BNC input connectors is shown hereafter in **Figure 16**:



Figure 16: Pinout for the TWIN BNC connector

Suggested Twin-ax mating connector: Amphenol RF 31-224



Figure 17: Twin-ax mating connector

The maximum peak voltage that can be applied between the external shield and the inner pins (positive or negative) is of 500 V.

The QDS unit has to be placed as closed as possible to the voltage source in order to minimize noise pick-up.

4.6 Interlocks/Status Connector

The 12-pin Interlock/Status connector on the front side of the device has different functions. Its pinout numbering is shown in

Figure 18.



Figure 18: Interlocks/Status connector

The connector on the QDS is the Weidmüller 1290260000 while the mating connector (already provided with the QDS) is the Weidmüller 1277900000. The pinout of the connector with the corresponding functions is described hereafter:

Pin #	Function
1	+24 V Persistent Switch Output
2	Persistent Switch Ground
3	+12 V Persistent Switch Output
4	Persistent Switch Ground
5	Magnetic Relay – Normally Open (NO)
6	Magnetic Relay – Center Tap (CT)
7	Magnetic Relay – Normally Closed (NC)
8	Magnetic Relay – Center Tap (CT)
9	External Interlock #1 – Positive
10	External Interlock #1 – Negative
11	External Interlock #2 – Positive
12	External Interlock #2 – Negative

4.6.1 Persistent Switch

The QDS includes the possibility of driving a Persistent Switch (e.g. for the heater) and it has two power outputs that can be enabled/disabled. Both outputs are enabled/disabled simultaneously and they are used to feed alternatively an external switch with 12-V or 24-V rating.

The maximum power that can be drawn on both outputs, if loaded together, is of 2.7 W.

The +24 V output power is drawn from pin #1 while the +12 V output from pin #3. The ground returns (being both output floating respect to ground) can be connected on pin #2 or pin #4.

The maximum current rating for the +24-V output is of 110 mA while the maximum current rating for the +12-V output is of 220 mA.

Ratings are shown in the following table:

Specifications	Value
Output Voltage (V_{OUT})	12 V 24 V
Maximum Output Current (I_{OUT})	220 mA (12 V) 110 mA (24 V)
Floating Output	Yes
Maximum Output Power	2.7 W

4.6.2 Magnetic Relay Output

The QDS also includes a magnetic relay with normally open, normally closed and center tap terminals available.

This can be used to signal a status to an external device (e.g. a quench detected) and when driven, the Normally Closed contact (NC, pin #7) switch opens while the Normally Open (NO, pin #5) one closes. This behaviour is also reproduced when the QDS unit is shut down, in order that a powered off unit can be detected as a quench/fault

status. The absolute maximum current that can be sunk by the output status magnetic relays (pins #5, #7 and #6, #8) is of 200 mA.

4.6.3 External Interlocks

The QDS has also two external interlocks (on pins #9-#10 and on pins #11-#12 respectively) that are galvanically isolated from ground and they are already supplied by an internal 24-V source. The two interlocks inputs have their own return connections.

The schematic of the interlock inputs is shown hereafter in **Figure 19**:

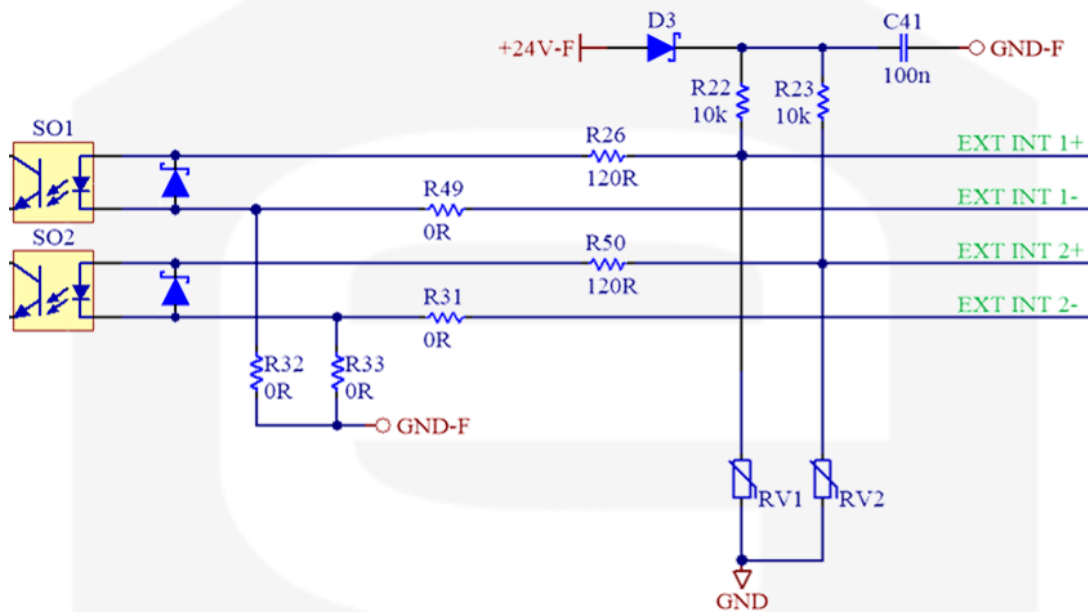

Figure 19: Schematic of the Interlock Inputs

These interlocks can be independently activated/deactivated by the user and they tripping direction can also be configured remotely.

PLEASE NOTE THAT THESE CONNECTORS ARE RESERVED FOR FUTURE USE AND NO FUNCTIONALITY IS IMPLEMENTED AT THE MOMENT.

5. Technical Specifications

Main technical specifications for the QDS unit are listed in the following table:

Specifications	Value
Input Channels	4
Input Polarity	Bipolar
Input Channel Type	Floating
Twinax pin-to-pin max voltage	200 V (DC)
Twinax pin-to-shield max voltage	500 V (DC)
Voltage Measuring Ranges	RANGE0 up to ± 20 V
	...
	RANGE10 up to ± 20 mV
Voltage Resolution (LSB)	RANGE0 2.4 μ V
	...
	RANGE10 2.5 nV
Internal Sampling Frequency	100 kHz
Sampling Resolution	24 bits
Integration Time (T)	from 1 ms to 1 s
Logger frequency	from 1 Hz to 1 kHz
Equivalent Input Bandwidth	T = 10 ms 45 Hz
	T = 50 ms 9 Hz
	T = 100 ms 5 Hz
	T = 500 ms 1 Hz
	T = 1 s 0.55 Hz
Temperature Coefficient - TC	0.0025 %/K
Communication	Ethernet 10/100/1000 TCP-IP
External Signals	2 x External Interlocks +24-V and +12-V Persistent Switch Power Magnetic Relay
Input Connectors	TWIN (Twinax) BNC

Interlocks/Status Connector	Weidmüller 1290260000 (mating: Weidmüller 1277900000)
Input Voltage Supply	+12 V
Cooling Method	Blower Fan
Dimensions	195 x 173 x 45 mm
Weight	850 g

5.1 Equivalent Input Noise

The equivalent input noise of the QDS depends both on the readout period/integration time (i.e. data rate) and the selected measuring range. The different readout periods imply a different equivalent dynamic response (i.e. bandwidth) for the analog input signal.

The equivalent rise time (10 → 90%) for different values of the readout period (integration time) is shown hereafter. Please note that these values are independent from the selected range.

Integration Time	Equivalent Rise Time (10/90)
10 ms	8 ms
50 ms	40 ms
100 ms	80 ms
500 ms	440 ms

A reference table with typical values for the equivalent input noise vs. the integration time (“T”) for each available range is shown hereafter.

Equivalent Input Noise (values in [ppm/FS] indicated below)

	T = 10 ms	T = 50 ms	T = 100 ms	T = 500 ms
RNG0 (± 20 V)	23 μV 1.2 ppm/FS	12 μV 0.6 ppm/FS	8 μV 0.4 ppm/FS	5 μV 0.3 ppm/FS
RNG1 (± 10 V)	12 μV 1.2 ppm/FS	6 μV 0.6 ppm/FS	4 μV 0.4 ppm/FS	3.5 μV 0.4 ppm/FS
RNG2 (± 5 V)	6 μV 1.2 ppm/FS	3.5 μV 0.7 ppm/FS	3 μV 0.6 ppm/FS	1.4 μV 0.4 ppm/FS
RNG3 (± 2.5 V)	3 μV 1.2 ppm/FS	1.8 μV 0.7 ppm/FS	1.3 μV 0.6 ppm/FS	900 nV 0.4 ppm/FS
RNG4 (± 1.25 V)	1.5 μV 1.2 ppm/FS	800 nV 0.7 ppm/FS	650 nV 0.6 ppm/FS	400 nV 0.4 ppm/FS
RNG5 (± 625 mV)	750 nV 1.2 ppm/FS	500 nV 0.8 ppm/FS	400 nV 0.7 ppm/FS	200 nV 0.4 ppm/FS
RNG6 (± 312.5 mV)	450 nV 1.5 ppm/FS	250 nV 0.8 ppm/FS	200 nV 0.7 ppm/FS	150 nV 0.5 ppm/FS
RNG7 (± 156.25 mV)	280 nV 1.8 ppm/FS	200 nV 1.3 ppm/FS	140 nV 0.9 ppm/FS	125 nV 0.8 ppm/FS
RNG8 (± 78.125 mV)	250 nV 3.2 ppm/FS	180 nV 2.3 ppm/FS	125 nV 1.6 ppm/FS	120 nV 1.6 ppm/FS
RNG9 (± 39.0625 mV)	230 nV 5.9 ppm/FS	150 nV 3.9 ppm/FS	120 nV 3.1 ppm/FS	115 nV 3.0 ppm/FS
RNG10 (± 19.53125 mV)	220 nV 11.3 ppm/FS	110 nV 5.6 ppm/FS	100 nV 5.2 ppm/FS	90 nV 4.6 ppm/FS

6. Mechanical Dimensions

The maximum mechanical dimensions of the QDS unit, including connectors, are hereafter presented in **Figure 20**:

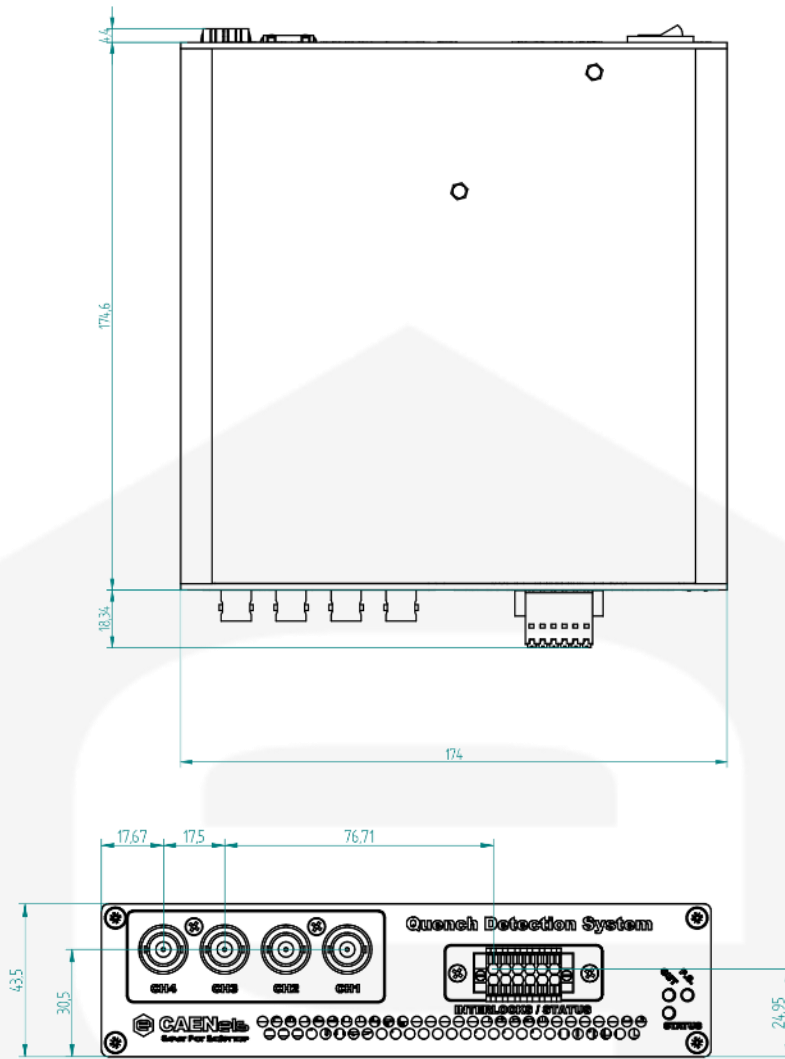

Figure 20: QDS mechanical dimensions

7. QDS Power Supply

This chapter describes the general characteristics and the main features of the QDS low-noise power supply called PS1112S. This power supply is particularly designed for operation with the CAENels QDS picoammeter.

7.1 The PS1112S Linear Power Supply

CAEN ELS PS1112S is a single-output +12 V mixed switching-linear power supply that is designed in order to obtain low-noise operation and high efficiency and it is especially suited for measurement systems where switching power supplies could corrupt measuring noise, accuracy and precision.

The power supply is housed in a robust and compact stainless-steel box that can be placed next to the supplied device in order to reduce cable lengths and minimize consequent possible noise pick-up.

7.2 The PS1112S at a Glance

The PS1112S linear power supply and its I/Os are represented in **Figure 21**. The PS1112S is an isolated power supply, with a 3-pole output connector, specifically designed to supply low current and precision instrumentation.

The AC Power Line input is placed on the left side of the box while the output connectors on the right side; LED monitor (indicating the presence of the output voltage) is placed on the front side.



Figure 21: overall view of a PS1112S power supply

The PS1112S is an isolated power supply, with a 3-pole output connector, specifically designed to supply low current and precision instrumentation.

The AC Power Line input is placed on the left side of the box while the output connectors on the right side; LED monitor (indicating the presence of the output voltage) is placed on the front side.

The PS1112S has a standard +12 V output voltage, as indicated in the following table:

	Positive Output Voltage
PS1112S	12 V @ 1.2 A

7.3 Technical Data

The PS1112S power supply has an output voltage accuracy of $\pm 3\%$ - i.e. from 11.64 V to 12.36 V.

Maximum peak-to-peak voltage noise measured at the device output terminals is rated at 4 mV. This value is measured over a 1 MHz bandwidth using a LeCroy MSO 44MXs-B, 400MHz, 5GS/s with AC Coupling at full load. A typical output waveform used to estimate the peak-to-peak noise value is shown in **Figure 22**.

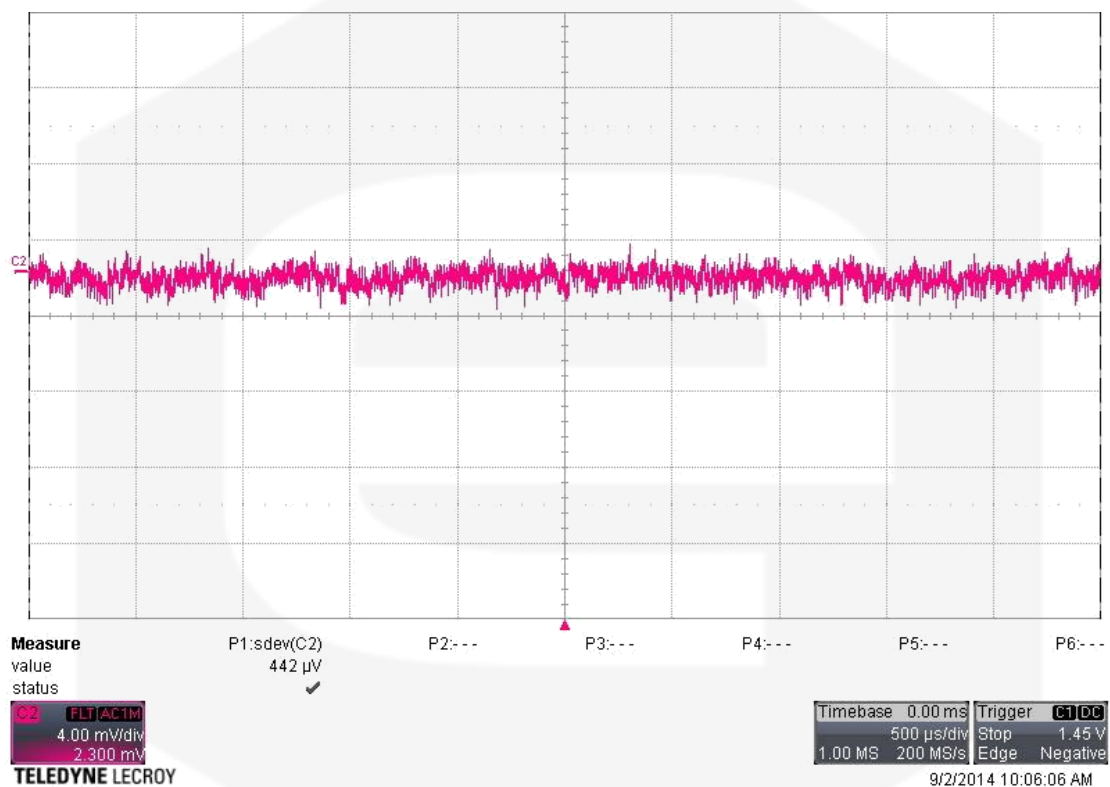

Figure 22: typical output noise - AC coupling

The PS1112S outputs are floating respect Earth up to 500V, protected against short-circuit and from over-voltage.

7.4 I/O Connectors

This chapter describes the I/O connectors and switches, their corresponding pinout and their functionality.

7.4.1 AC Line Input Connector

The AC Line Input connector is in a standard IEC Male Socket as shown in **Figure 23**.

The PS1112S power supply is designed for universal AC input voltage range since it can operate with voltage from 90V to 260V and input frequency from 47 to 63 Hz. Under the value of 115V AC Mains input, the Power Supply is subject to current (i.e. power) de-rating.



Figure 23: AC Line input connector

7.4.2 Output

Output DC voltage is made available through a 3-pole connector with a screw locking. The pin-out of the connector (frontal view) is shown in **Figure 24**.

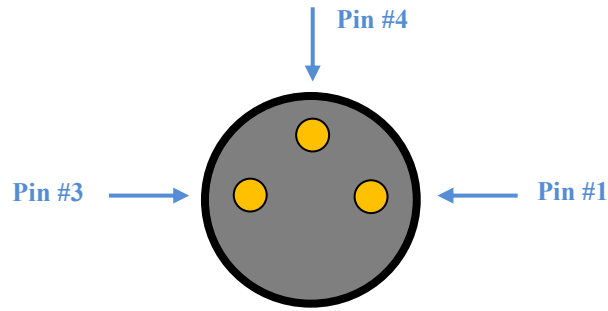

Figure 24: Output DC Connector (TE 1838839-1)

The output connector has the following pin-out:

Pin #	PS112S
1	+12V
3	nc
4	GND

In the same package of the power supply PS112S there is also a mating un-terminated cable that can be terminated with the desired connector.

7.4.3 Status LED

On a lateral side of the power supply, two LEDs turn off whenever the +12V is not correctly regulated on the output cable.



Figure 25: LED indicators for output voltage

7.4.4 Mechanical Fixing

On the bottom side of the PS1112S four threaded M3×4mm holes can be used for fixing the power supply. These are indicated in the following **Figure 26**.

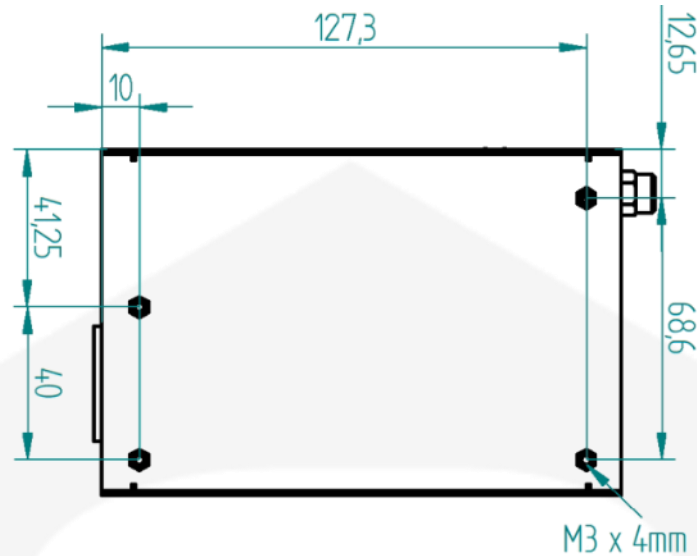

Figure 26: Threaded holes position on the PS1112S bottom

7.5 Mounting position

The PS1112S shall **NOT be mounted** in the two following positions:

- bottom side of the box fixed to the ceiling (**Figure 27**);
- lateral side of the box that present ten ventilation holes faced to the top (**Figure 28**).

The RECOMMENDED mounting positions for increasing the heat dissipation and increasing reliability and life-time are:

- bottom side of the box fixed to the floor;
- lateral side of the box that present twenty ventilation holes faced to the top.



Figure 27: Ceiling mounting NOT allowed

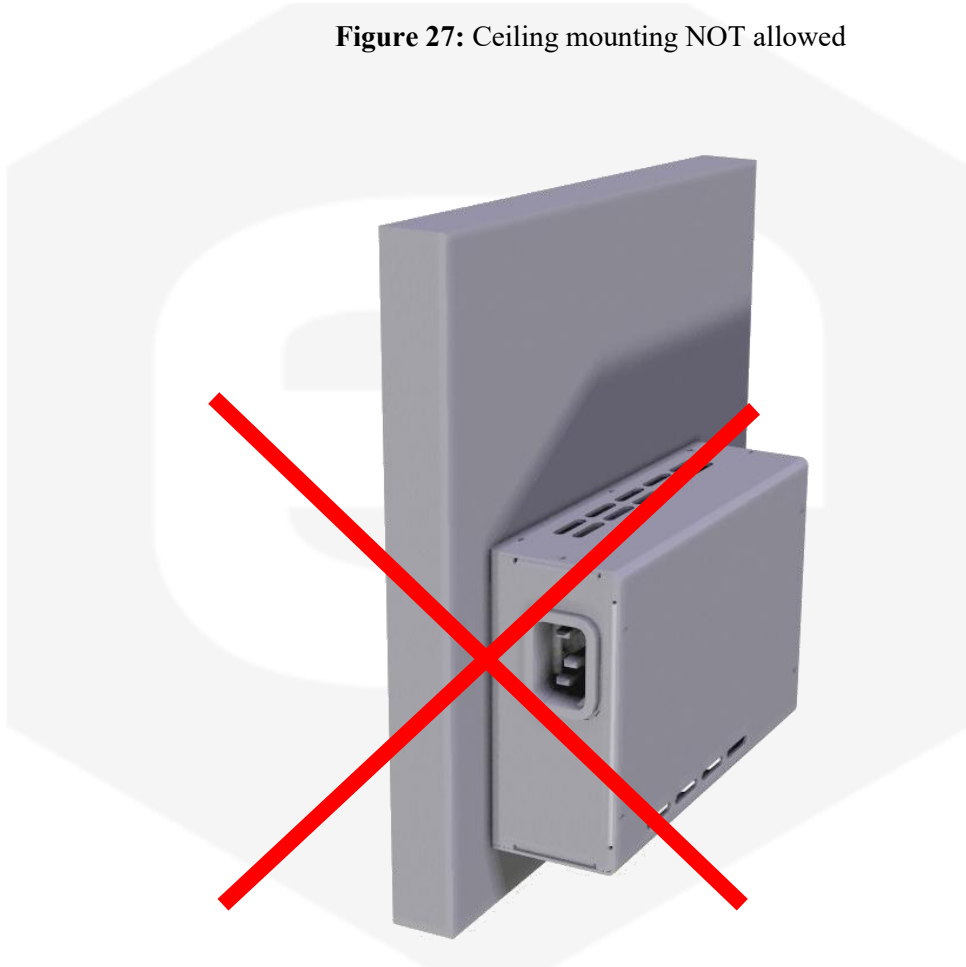

Figure 28: Lateral mounting (ten ventilation holes faced to the top) NOT allowed

7.6 Technical Specifications

Technical Specifications for the PS1112S power supply are presented in the following table:

Technical Specifications	PS1112S
Output Voltage ($\pm 3\%$)	+12 V
Maximum Output Power	14.4 W
Maximum Output Current	+12V @ 1.2 A
Output Ripple + Noise	0.003 % _{RMS} @ DC-1MHz 0.025 % _{P-P} @ DC-1MHz
AC Line Voltage Input	90 – 260 V _{AC}
AC Line Frequency	47 - 63 Hz
Input to Output Isolation	3 kV
Output to Earth-Case Isolation	500 V
Hold-up time	16 ms typ. at 115 V _{AC}
Cooling	Natural convection
Dimensions	136.4 × 41 × 90.7 mm
Weight	600 g
Y-Cable length (CT-I and CT-V)	3 m
Indicators	1 LED (Power Good)
Protections	Output short-circuit Output over-voltage
Operating Temperature Range	0 °C – 50 °C

8. 19"-2U Mounting Crate - *optional*

8.1 Description

A 19"2U mounting crate is also available in order to mount up to two TetrAMM devices (as shown in the picture), together with their respective PS1112S power supplies in a standard cabinet. This unit is also compatible with the PreDAC devices the EnBOX devices and the QDS devices by CAEN ELS.

A single 19"-2U crate, metal and plastic-made, can house up to two QDS devices as shown in **Figure 29** and **Figure 30**. The devices can be mounted with the front-end and bias connectors on the front and the communication/interlock/etc. on the rear side or vice-versa.

The QDS housed in the box are not in direct contact with metal part and so the front-ends and the bias voltage can be floating respect to the external case (i.e. Protective Earth PE) up to ± 30 V. This allows the QDS, for example, to work as a bias device for silicon photodiodes in order to characterize their behavior.



Figure 29: 19"-2U crate front view



Figure 30: 19"-2U crate rear view

The connections of the PS1112S to the AC mains and from the PS1112S to the QDS unit needs to be performed as shown in **Figure 31**:



Figure 31: power supply connections

The ordering code for these 19"-2U crates is hereafter shown (please indicate the ordering code and its description at the time of order):

Ordering Code	Description
MEC--BEI0007	19"-2U Mounting Tray for 2 TetrAMM, QDS, PreDAC or EnBox Devices

The mounting crate/tray has a total depth of approximately 175 mm, excluding the QDS connectors (other dimensions are standard 19" width and 2U height). The total weight of the 19"-2U mounting crate filled with both QDSs and their respective power supplies is of 4,850 kg (approximately 10,7 lbs).

