

# TetrAMM

4-Channel Fast Interface Bipolar  
Picoammeter with Integrated Voltage  
Bias Source



User's Manual



All Rights Reserved  
© ELS Instruments srl  
Rev. 4.6 – June 2026

This product is  compliant.

 **ELS Instruments srl**

Via Karl Ludwig Von Bruck 32– 34144 Trieste (TS)  
Italy

Mail: [info@caenels.com](mailto:info@caenels.com)

Web: [els-instruments.com](http://els-instruments.com)

*Registered office: via Karl Ludwig Von Bruck 32 – 34144 Trieste (TS) - Italy*



## EU DECLARATION OF CONFORMITY

Product:

Beamline Electronic Instrumentation  
**ELS Instruments srl – TetrAMM series**

WTETRAMMC0XX - 4-channel Fast Interface Bipolar  
Picoammeter with Integrated High-Voltage Source

Manufacturer:

**ELS Instruments srl**  
Via Karl Ludwig Von Bruck 32  
34144 Trieste (TS)  
Italy

This declaration of conformity is issued under the sole responsibility of the manufacturer.

Object of the Declaration:

Beamline Electronic Instrumentation  
**Brand: ELS Instruments srl**  
**Model Family: TetrAMM**



The object of the declaration described above is in conformity with the relevant Union harmonisation legislation:

- 2014/30/EU:** Electromagnetic Compatibility (EMC) Directive
- 2014/35/EU:** Low Voltage Directive (LVD)
- 2011/65/EU** and **2015/863/EU:** Restriction of Hazardous Substances (RoHS) Directive

References to the relevant harmonised standards used or references to the other technical specifications in relation to which conformity is declared:

- EN 61326-1:2013** *Electrical equipment for measurement, control and laboratory use - EMC requirements -- Part 1: General requirements.*
- EN 61010-1:2010** *Safety requirements for electrical equipment for measurement, control, and laboratory use -- Part 1: General requirements.*

Signed for and on behalf of: ELS Instruments srl

Trieste – May 29<sup>th</sup>, 2026

Enrico Braidotti, CEO



# Table Of Contents

<b>1.</b>	<b>INTRODUCTION.....</b>	<b>11</b>
1.1	THE TETRAMM PICOAMMETER .....	11
1.2	THE TETRAMM AT A GLANCE .....	12
1.3	FEATURES .....	14
1.4	BIAS VOLTAGE SOURCE.....	15
1.5	DATA FORMAT.....	15
1.6	SAMPLING FREQUENCY.....	16
1.7	OFFSET CALIBRATION.....	16
1.7.1	<i>User Defined Calibration</i> .....	16
1.8	ORDERING CODES.....	17
<b>2.</b>	<b>SOFTWARE COMMANDS .....</b>	<b>19</b>
2.1	COMMAND SYNTAX .....	19
2.2	ACQUISITION COMMANDS.....	20
2.2.1	<i>ACQ Command</i> .....	21
2.2.2	<i>GET Command</i> .....	25
2.2.3	<i>NAQ Command</i> .....	26
2.2.4	<i>TRG Command</i> .....	28
2.2.5	<i>FASTNAQ Command</i> .....	33
2.3	CONFIGURATION COMMANDS.....	34
2.3.1	<i>IFCONFIG Command</i> .....	34
2.3.2	<i>HELP Command</i> .....	35
2.3.3	<i>CHN Command</i> .....	35
2.3.4	<i>ASCII Command</i> .....	36
2.3.5	<i>RNG Command</i> .....	38
2.3.6	<i>USRCORR Command</i> .....	40
2.3.7	<i>NRSAMP Command</i> .....	42
2.3.8	<i>STATUS Command</i> .....	43
2.3.9	<i>PKTSIZE Command</i> .....	46
2.3.10	<i>INTERLOCK Command</i> .....	48
2.3.11	<i>TEMP Command</i> .....	49
2.3.12	<i>VER Command</i> .....	49
2.3.13	<i>HWRESET Command</i> .....	50
2.3.14	<i>TRGPOL Command</i> .....	50
2.3.15	<i>NTRG Command</i> .....	51
2.3.16	<i>SEQNR Command</i> .....	51
2.3.17	<i>TRGOUT and THR Commands</i> .....	52
2.3.17.1	<i>TRGOUT Enable Command</i> .....	52
2.3.17.2	<i>THR Threshold Command</i> .....	53
2.3.17.3	<i>THR Threshold Comparison Command</i> .....	53
2.3.17.4	<i>THR Set Average Samples</i> .....	54
2.3.17.5	<i>TRGOUT Edge Command</i> .....	54
2.3.17.6	<i>TRGOUT Mode Command</i> .....	55
2.3.17.7	<i>TRGOUT Status Command</i> .....	55
2.4	DEVID COMMAND.....	56
2.5	BIAS VOLTAGE COMMANDS .....	56

2.5.1	<i>HVS Command</i> .....	56
2.5.1.1	Low-Voltage bias module: additional commands .....	57
2.5.2	<i>HVV Command</i> .....	59
2.5.3	<i>HVI Command</i> .....	59
2.6	COMMAND TABLE SUMMARY .....	60
<b>3.</b>	<b>ETHERNET COMMUNICATION .....</b>	<b>63</b>
3.1	IP ADDRESS ASSIGNMENT .....	63
3.2	ELS DEVICE MANAGER.....	64
3.2.1	<i>Searching for connected devices</i> .....	64
3.2.2	<i>Device Configuration</i> .....	66
3.2.3	<i>Firmware Upgrade</i> .....	67
<b>4.</b>	<b>I/O CONNECTORS.....</b>	<b>68</b>
4.1	POWER CONNECTOR .....	68
4.2	TRIGGERS CONNECTOR.....	69
4.3	INTERLOCK AND GENERAL I/O CONNECTOR .....	70
4.4	ETHERNET AND SFP CONNECTOR .....	72
4.5	INPUT BNC CONNECTORS .....	72
4.6	OUTPUT BIAS VOLTAGE CONNECTOR.....	73
4.6.1	<i>Low-Voltage Bias Connector (BNC)</i> .....	73
4.6.2	<i>High-Voltage Bias Connector (SHV)</i> .....	74
<b>5.</b>	<b>TECHNICAL SPECIFICATIONS .....</b>	<b>75</b>
5.1	EQUIVALENT INPUT NOISE.....	76
<b>6.</b>	<b>MECHANICAL DIMENSIONS.....</b>	<b>79</b>
<b>7.</b>	<b>TETRARAMM POWER SUPPLY.....</b>	<b>80</b>
7.1	THE PS1112S LINEAR POWER SUPPLY .....	80
7.2	THE PS1112S AT A GLANCE .....	80
7.3	TECHNICAL DATA .....	82
7.4	I/O CONNECTORS.....	83
7.4.1	<i>AC Line Input Connector</i> .....	83
7.4.2	<i>Output</i> .....	83
7.4.3	<i>Status LED</i> .....	84
7.4.4	<i>Mechanical Fixing</i> .....	85
7.5	MOUNTING POSITION .....	85
7.6	TECHNICAL SPECIFICATIONS.....	87
<b>8.</b>	<b>19"-2U MOUNTING CRATE - <i>OPTIONAL</i> .....</b>	<b>88</b>
8.1	DESCRIPTION .....	88
<b>9.</b>	<b>APPENDIX.....</b>	<b>90</b>
9.1	LIST OF THE ERROR CODES .....	90

<b>Document Revision</b>	<b>Date</b>	<b>Comment</b>
0.1	September 8 <sup>th</sup> , 2013	Document created
0.8	October 28 <sup>th</sup> , 2013	Document update
1.0	November 15 <sup>nd</sup> , 2013	First Release version
1.1	January 31 <sup>st</sup> , 2014	Corrections on ACQ query command description
1.2	February 5 <sup>th</sup> , 2014	AC/DC part changed
1.3	March 17 <sup>th</sup> , 2014	Maintenance release and correction on some data
1.4	July 25 <sup>th</sup> , 2014	AC/DC part updated
1.5	October 29 <sup>th</sup> , 2014	Manual Graphics changed
1.6	January 9 <sup>th</sup> , 2016	Updated ordering codes, added PS1112S section
1.7	November 16 <sup>th</sup> , 2016	Document update
1.8	March 29 <sup>th</sup> , 2018	Document update (relative to firmware release 3.0.00)
1.9	August 27 <sup>th</sup> , 2019	Added new ordering codes
1.10	September 19 <sup>th</sup> , 2019	Added WTETRAMMC006 ordering code
1.11	November 15 <sup>th</sup> , 2019	Additional information on interlock operation
1.12	December 20 <sup>th</sup> , 2019	Added new interlock features. Firmware upgrade procedure updated (see section 3.2.3)
1.13	February 14 <sup>th</sup> , 2020	Added WTETRAMMC008 ordering code
2.0	July 13 <sup>th</sup> , 2020	Description of old ordering codes removed, corrected max noise values, 19"-2U mounting crate added. Changed some wrong bandwidth data.
2.1	August 7 <sup>th</sup> , 2020	Added commands for Low-Voltage bias module.
2.2	January 27 <sup>th</sup> , 2021	Added WTETRAMMC007, WTETRAMMC011 and WTETRAMMC012 ordering codes
2.3	May 7 <sup>th</sup> , 2021	Added WTETRAMMC013
2.4	July 12 <sup>th</sup> , 2021	Added WTETRAMMCAPS and 2U rack images updated
2.5	October 4 <sup>th</sup> , 2021	Added WTETRAMMC014
2.6	November 22 <sup>nd</sup> , 2022	Added UKCA compliance logo
2.7	February 8 <sup>th</sup> , 2023	Added DEVID command
2.8	June 1 <sup>st</sup> , 2023	Added TRGOUT and THR commands.

2.9	July 10 <sup>th</sup> , 2023	Updated PKTSIZE command. Corrected HWRESET command.
3.0	August 22 <sup>nd</sup> , 2023	Added WTETRAMMC015
3.1	September 19 <sup>th</sup> , 2023	Added WTETRAMMC016
3.2	December 14 <sup>th</sup> , 2023	Added section on NTRG command. Moved TRGOUT, THR and TRGPOL commands in section "Configuration Commands". Updated max settable value by PKTSIZE command.
3.3	August 2 <sup>nd</sup> , 2024	Added WTETRAMMC019
4	August 8 <sup>th</sup> 2024	Updated address and revision numbering
4.1	October 9 <sup>th</sup> , 2024	Added WTETRAMMC017 and WTETRAMMC018
4.2	March 31 <sup>st</sup> , 2025	Added WTETRAMMC020
4.3	December 3 <sup>rd</sup> , 2025	Modified TRG command section, fixed typos, added SEQNR command, fixed commands descriptions
4.4	December 12 <sup>th</sup> , 2025	Modified TEMP and VER commands description, fixed section 4.2
4.5	February 18 <sup>th</sup> , 2026	Added WTETRAMMC021
4.6	June 3 <sup>rd</sup> , 2026	Added LEMO mating connector part number. Added the Declaration of Conformity. Moved from CAEN ELS to ELS Instruments.

## User Manual – Models – Options – Custom Models

*This manual covers the following TetrAMM models:*

Ordering Code	Ranges	BIAS	BW	Description
<b>WTETRAMMNOHV</b>	$\pm 120 \mu\text{A}$ $\pm 120 \text{nA}$	/	4 kHz	4-channel Fast Interface Bipolar Picoammeter without Integrated HV Source
<b>WTETRAMM05PX</b>	$\pm 120 \mu\text{A}$ $\pm 120 \text{nA}$	+ 500 V	4 kHz	4-channel Fast Interface Bipolar Picoammeter with Integrated +500V HV Source
<b>WTETRAMM05NX</b>	$\pm 120 \mu\text{A}$ $\pm 120 \text{nA}$	- 500 V	4 kHz	4-channel Fast Interface Bipolar Picoammeter with Integrated -500V HV Source
<b>WTETRAMM20PX</b>	$\pm 120 \mu\text{A}$ $\pm 120 \text{nA}$	+2 kV	4 kHz	4-channel Fast Interface Bipolar Picoammeter with Integrated +2kV HV Source
<b>WTETRAMM20NX</b>	$\pm 120 \mu\text{A}$ $\pm 120 \text{nA}$	-2 kV	4 kHz	4-channel Fast Interface Bipolar Picoammeter with Integrated -2kV HV Source
<b>WTETRAMM40PX</b>	$\pm 120 \mu\text{A}$ $\pm 120 \text{nA}$	+4 kV	4 kHz	4-channel Fast Interface Bipolar Picoammeter with Integrated +4kV HV Source
<b>WTETRAMM40NX</b>	$\pm 120 \mu\text{A}$ $\pm 120 \text{nA}$	-4 kV	4 kHz	4-channel Fast Interface Bipolar Picoammeter with Integrated -4kV HV Source
<b>WTETRAMMC001</b>	$\pm 1.2 \mu\text{A}$ $\pm 1.2 \text{nA}$	- 500 V	100 Hz	4-channel Picoammeter with Integrated -500V HV (RNG: $\pm 1.2 \mu\text{A}$ , $\pm 1.2 \text{nA}$ )
<b>WTETRAMMC002</b>	$\pm 1.2 \text{mA}$ $\pm 1.2 \mu\text{A}$	+ 500 V	5 kHz	4-channel Picoammeter with Integrated +500V HV (RNG: $\pm 1.2 \text{mA}$ , $\pm 1.2 \mu\text{A}$ )
<b>WTETRAMMC003</b>	$\pm 25 \mu\text{A}$ $\pm 250 \text{nA}$	/	5 kHz	4-channel Picoammeter without Integrated HV (RNG: $\pm 25 \mu\text{A}$ , $\pm 250 \text{nA}$ )
<b>WTETRAMMC004</b>	$\pm 120 \mu\text{A}$ $\pm 120 \text{nA}$	+ 500 V	20 kHz > 5 kHz	4-channel Picoammeter with Integrated + 500V HV (RNG: $\pm 120 \mu\text{A}$ , $\pm 120 \text{nA}$ )
<b>WTETRAMMC005</b>	$\pm 10 \mu\text{A}$ $\pm 125 \text{nA}$	- 500 V	5 kHz	4-channel Picoammeter with Integrated -500V HV (RNG: $\pm 10 \mu\text{A}$ , $\pm 125 \text{nA}$ )
<b>WTETRAMMC006</b>	$\pm 10 \mu\text{A}$ $\pm 2 \mu\text{A}$	/	5 kHz	4-channel Picoammeter without Integrated HV (RNG: $\pm 10 \mu\text{A}$ , $\pm 2 \mu\text{A}$ )
<b>WTETRAMMC007</b>	$\pm 25 \mu\text{A}$ $\pm 250 \text{nA}$	-4 kV	5 kHz	4-channel Picoammeter with Integrated -4 kV HV (RNG: $\pm 25 \mu\text{A}$ , $\pm 250 \text{nA}$ , BW = 5 kHz)
<b>WTETRAMMC008</b>	$\pm 6 \text{mA}$ $\pm 20 \mu\text{A}$	+500 V	2 kHz 1 kHz	4-channel Picoammeter with Integrated +500V HV (RNG: $\pm 6 \text{mA}$ BW = 2 kHz, $\pm 20 \mu\text{A}$ BW = 1 kHz)
<b>WTETRAMMC009</b>	$\pm 20 \mu\text{A}$ $\pm 2 \mu\text{A}$	$\pm 30 \text{V}$	1 kHz	4-channel Picoammeter with Integrated $\pm 30 \text{V}$ bias (RNG: $\pm 20 \mu\text{A}$ , $\pm 2 \mu\text{A}$ , BW=1 kHz)

<b>WTETRAMMC010</b>	$\pm 120 \mu\text{A}$ $\pm 120 \text{nA}$	$\pm 30 \text{ V}$	20 kHz > 5 kHz	4-channel Picoammeter with Integrated $\pm 30\text{V}$ bias (RNG: $\pm 120 \text{ uA}$ BW = 20 kHz, $\pm 120 \text{ nA}$ BW > 5 kHz)
<b>WTETRAMMC011</b>	$\pm 1.2 \text{ mA}$ $\pm 1.2 \mu\text{A}$	$\pm 30 \text{ V}$	20 kHz	4-channel Picoammeter with Integrated $\pm 30\text{V}$ bias (RNG: $\pm 1.2 \text{ mA}$ , $\pm 1.2 \text{ uA}$ , BW = 20 kHz)
<b>WTETRAMMC012</b>	$\pm 60 \mu\text{A}$ $\pm 15 \mu\text{A}$	$\pm 30 \text{ V}$	1 kHz	4-channel Picoammeter with Integrated $\pm 30\text{V}$ bias (RNG: $\pm 60 \text{ uA}$ , $\pm 15 \text{ uA}$ , BW = 1 kHz)
<b>WTETRAMMC013</b>	$\pm 1.2 \text{ mA}$ $\pm 1.2 \mu\text{A}$	- 500 V	5 kHz	4-channel Picoammeter with Integrated -500V HV (RNG: $\pm 1.2 \text{ mA}$ , $\pm 1.2 \text{ uA}$ , BW = 5 kHz)
<b>WTETRAMMCAPS</b>	$\pm 60 \mu\text{A}$ $\pm 15 \mu\text{A}$	$\pm 5 \text{ V}$	1 kHz	4-channel Picoammeter with Integrated $\pm 6\text{V}$ bias (RNG: $\pm 60 \text{ uA}$ , $\pm 15 \text{ uA}$ , BW = 1 kHz)
<b>WTETRAMMC014</b>	$\pm 2 \text{ mA}$ $\pm 50 \mu\text{A}$	$\pm 30 \text{ V}$	5 kHz	4-channel Picoammeter with Integrated $\pm 30\text{V}$ bias (RNG: $\pm 2 \text{ mA}$ , $\pm 50 \text{ uA}$ , BW = 5 kHz)
<b>WTETRAMMC015</b>	$\pm 1.2 \mu\text{A}$ $\pm 1.2 \text{ nA}$	$\pm 30 \text{ V}$	100 Hz	4-channel Picoammeter with Integrated $\pm 30\text{V}$ Bias (RNG: $\pm 1.2 \text{ uA}$ , $\pm 1.2 \text{ nA}$ , BW=100Hz)
<b>WTETRAMMC016</b>	$\pm 12 \text{ mA}$ $\pm 12 \mu\text{A}$	$\pm 30 \text{ V}$	20 kHz	4-channel Picoammeter with Integrated $\pm 30 \text{ V}$ (RNG: $\pm 12 \text{ mA}$ , $\pm 12 \text{ uA}$ , BW=20 kHz)
<b>WTETRAMMC017</b>	$\pm 1.2 \mu\text{A}$ $\pm 1.2 \text{ nA}$	/	100 Hz	4-channel Picoammeter without Integrated HV Bias (RNG: $\pm 1.2 \text{ uA}$ , $\pm 1.2 \text{ nA}$ , BW=100Hz)
<b>WTETRAMMC018</b>	$\pm 1.2 \mu\text{A}$ $\pm 1.2 \text{ nA}$	+500 V	100 Hz	4-channel Picoammeter with Integrated +500V HV Bias (RNG: $\pm 1.2 \text{ uA}$ , $\pm 1.2 \text{ nA}$ , BW=100Hz)
<b>WTETRAMMC019</b>	$\pm 120 \mu\text{A}$ $\pm 120 \text{ nA}$	/	1 kHz	4-channel Picoammeter without Integrated Bias (RNG: $\pm 120 \text{ uA}$ , $\pm 120 \text{ nA}$ , BW=1 kHz)
<b>WTETRAMMC020</b>	$\pm 1.6 \mu\text{A}$ $\pm 120 \text{ nA}$	$\pm 30 \text{ V}$	1 kHz	4-channel Picoammeter with Integrated $\pm 30 \text{ V}$ bias (RNG: $\pm 1.6 \text{ uA}$ , $\pm 120 \text{ nA}$ , BW=1 kHz)
<b>WTETRAMMC021</b>	$\pm 5 \mu\text{A}$ $\pm 5 \text{ nA}$	$\pm 30 \text{ V}$	500 Hz	4-channel Picoammeter with Integrated $\pm 30 \text{ V}$ bias (RNG: $\pm 5 \text{ uA}$ , $\pm 5 \text{ nA}$ , BW=500 Hz)

## **Safety information – Warnings**

ELS Instruments will repair or replace any product within the guarantee period if the Guarantor declares that the product is defective due to workmanship or materials and has not been caused by mishandling, negligence on behalf of the User, accident or any abnormal conditions or operations.

**Please read carefully the manual before operating any part of the instrument**



### **Do NOT open the boxes**

**ELS Instruments srl declines all responsibility for damages or injuries caused by an improper use of the Modules due to negligence on behalf of the User. It is strongly recommended to read thoroughly this User's Manual before any kind of operation.**

ELS Instruments srl reserves the right to change partially or entirely the contents of this Manual at any time and without giving any notice.

### **Disposal of the Product**

The product must never be dumped in the Municipal Waste. Please check your local regulations for disposal of electronics products.



Read over the instruction manual carefully before using the instrument.  
The following precautions should be strictly observed before using the TetrAMM device:

---

**WARNING**

- Do not use this product in any manner not specified by the manufacturer. The protective features of this product may be impaired if it is used in a manner not specified in this manual.
- Do not use the device if it is damaged. Before you use the device, inspect the instrument for possible cracks or breaks before each use.
- Do not operate the device around explosives gas, vapor or dust.
- Always use the device with the cables provided.
- Turn off the device before establishing any connection.
- Do not operate the device with the cover removed or loosened.
- Do not install substitute parts or perform any unauthorized modification to the product.
- Return the product to the manufacturer for service and repair to ensure that safety features are maintained

---

**CAUTION**

- This instrument is designed for indoor use and in area with low condensation.

The following table shows the general environmental requirements for a correct operation of the instrument:

<b>Environmental Conditions</b>	<b>Requirements</b>
Operating Temperature	0°C to 40°C
Operating Humidity	30% to 85% RH (non-condensing)
Storage Temperature	-10°C to 60°C
Storage Humidity	5% to 90% RH (non-condensing)



# 1. Introduction

This chapter describes the general characteristics and main features of the TetrAMM 4-Channel Bipolar Picoammeter with integrated Voltage Bias Source.

## 1.1 The TetrAMM Picoammeter

The TetrAMM picoammeter by ELS Instruments is a 4-channel, 24-bit resolution, wide-bandwidth, wide input dynamic range picoammeter with an integrated bias source up to 4000 V. Models available have a full-bipolar  $\pm 30$  V bias source or high-voltage modules available in both polarities rated at 500 V, 2000 V or 4000 V.

The device is composed of a specially designed transimpedance input stage for current sensing combined with analog signal conditioning and filtering stages making use of state-of-the-art electronics. This device can perform bipolar current measurements from  $\pm 120$  nA (with a resolution of about 15 fA) up to  $\pm 120$   $\mu$ A (resolution of 15 pA) with a sampling frequencies of 100 kHz (for 4 channel at 24-bit resolution). Low temperature drifts, good linearity and very low noise levels enable users to perform very high-precision current measurements.

The TetrAMM is housed in a light, robust and extremely compact metallic box that can be placed as close as possible to the current source (detector), in order to reduce cable lengths and minimize possible noise pick-up. It is specially suited for applications where multi-channel simultaneous acquisitions are required, a typical application being the currents readout from 4-quadrant photodiodes used to monitor X-ray beam displacements.

Most of this manual refers to the **WTETRAMM05PX (4-channel Fast Interface Bipolar Picoammeter with Integrated +500V HV Source)** model as an example.

The TetrAMM communication is guaranteed by a standard 10/100/1000 Mbps Ethernet TCP/IP protocol.

## 1.2 The TetrAMM at a Glance

The TetrAMM unit and its I/O connections can be easily seen in **Figure 1** (front) and in **Figure 2** (rear).

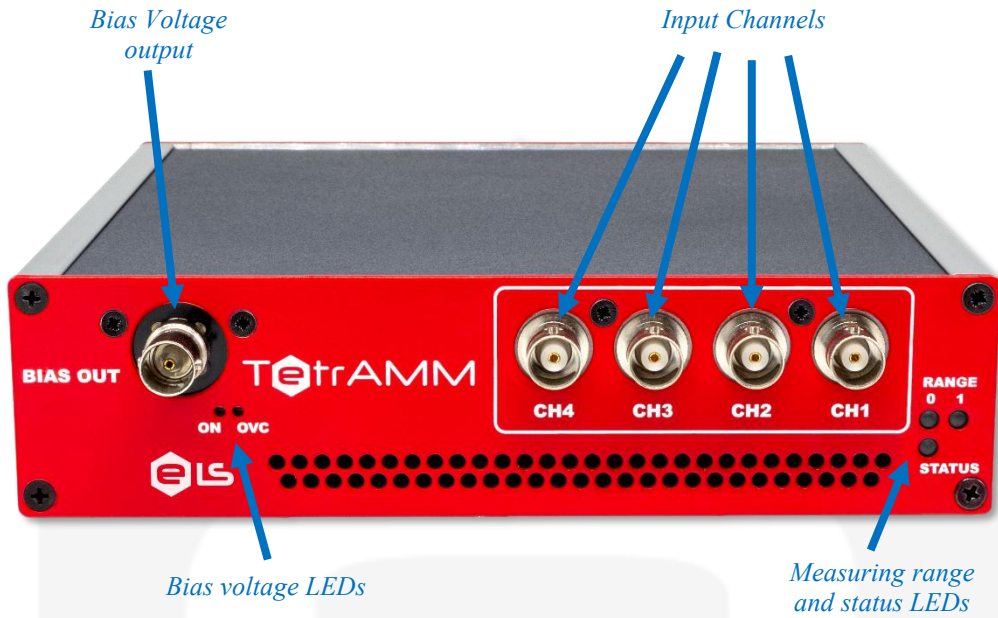

**Figure 1:** front view of a TetrAMM unit (version with the HV bias)

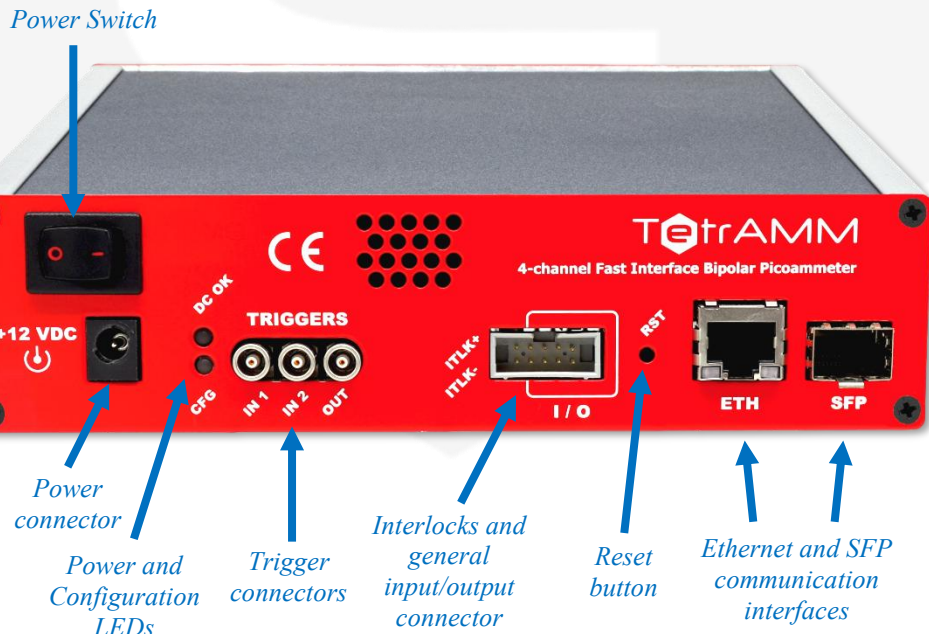

**Figure 2:** rear view of a TetrAMM unit

On the front side of the TetrAMM unit are placed four analog BNC current input connectors for input current measuring, one Bias Voltage output connector (it is a standard BNC connector for the  $\pm 30$  V bias version and a SHV connector for the High-Voltage bias models) and various status LEDs.

The two white “Range LEDs” (“ $\mu$ A” and “nA” in the standard configuration) are used in order to signal which of two ranges is currently used to measure the input current. If both LEDs are turned on, then the input channels are using different ranges (for more information see RNG Command section). Right under the “Range LEDs” is placed a blue “Status LED”, which is used to signal the correct operation of the picoammeter device. During normal operation of the TetrAMM unit the “Status LED” is blinking with a frequency of 0.5Hz – i.e. the LED changes its status every 2 seconds – on the other hand, if a fault condition arises, the LED blinks with a higher frequency of 2 Hz (the led changes its status every 0.5 seconds). During the boot phase of the TetrAMM unit (which takes about 12 seconds) the “Status LED” and the “Range LEDs” are all turned on.

Two “Bias Voltage LEDs” are placed under the Bias Voltage output connector (BNC or SHV): the “ON” led is used to signal that the Bias Voltage output is enabled while the “OVC” LED is turned ON when the Bias Voltage module is in over-current condition.

On the rear panel of the device are placed power connector, power switch, two LEDs, LEMO connectors for I/O triggers, interlock and general I/O connector, a standard RJ45 Ethernet connector and an SFP connector.

The blue “CFG” led shows that the unit’s FPGA is correctly configured (in this case the LED is turned on). The green “DC OK” LED indicates that the internal sections are correctly powered.

The three LEMO connectors for I/O triggers are also placed on the rear panel. Please note that only “IN 1” signal is enabled and could be used for a synchronized data acquisition (see the Triggers Connector section). The other two connectors – i.e. “IN 2” and “OUT” – are reserved for future use.

The “Interlocks and general I/O connector” has the pinout configuration shown in **Figure 3**:

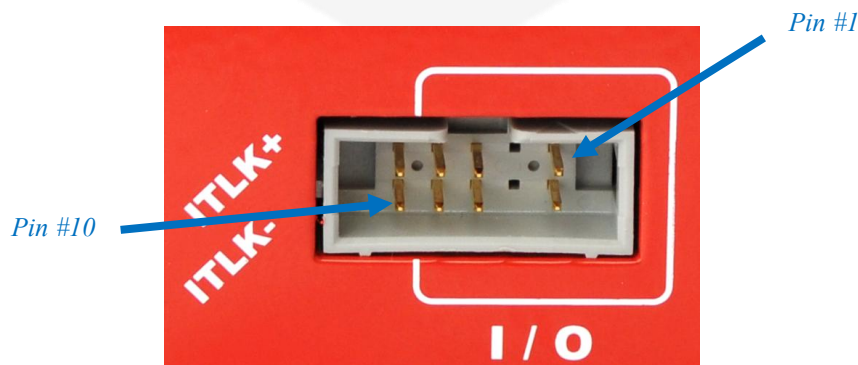

**Figure 3:** Interlock and general I/O connector

Pin #	Function
1-2	Reserved
3-4	Not present
5-8	General purpose I/O
9-10	External interlock

The external interlock pins can be used to detect an external event, which can be used to trigger the external interlock fault and so to switch off the Bias Voltage module (see Interlock and general I/O connector section for more information). This can be for example related to some vacuum-loss switch in beamline applications. Please note that these interlock pins are galvanically isolated from ground.

The General purpose I/O pins are not yet used and they are reserved for future use.

On the rear panel of the TetrAMM there is a small hole that gives access to a reset button (“RST”), which can be used to reset the unit. Next to the reset button are placed a RJ45 Ethernet connector (“ETH”), which is used to communicate with the unit and a Small Form-factor Pluggable transceiver (“SFP”) which is used to communicate with the BEST system.

### 1.3 Features

The TetrAMM input stage is based on four inverting transimpedance amplifiers (I/V converter) cascaded with particular signal conditioning stages.

Two standard measuring ranges are available; these range values with their corresponding gains and the resolution (LSB of the 24-bit Analog to Digital Converter) are shown in the following table:

	Full Scale	Gain (V/A)	Resolution (LSB)
<b>RNG 0</b>	$\pm 120 \mu A$	$-(20 \cdot 10^3)$	15 pA
<b>RNG 1</b>	$\pm 120 nA$	$-(20 \cdot 10^6)$	15 fA

A host PC is necessary in order to operate the TetrAMM unit and properly set/check the desired parameters (e.g. range) and to acquire the converted data. Please refer to the Software commands chapter for a complete description of available commands, their purposes and their syntax.

## 1.4 Bias Voltage Source

The TetrAMM device is provided with a low-noise integrated bias voltage source that can be mainly of two types:

- a Low-Voltage (LV) full-bipolar source rated at  $\pm 30$  V;
- a High-Voltage (HV) unipolar source rated at 500 V, 2 kV or 4 kV with factory-selectable polarity.

Please note that the bias source output is referred to the TetrAMM ground (i.e. the BNC connector outer shield).

This bias source is perfectly suited to be used as the bias voltage for the detecting system, when necessary, in order to increase the signal value (and thus to increase the signal-to-noise ratio).

The digital interface allows setting remotely the set point of the bias voltage source and to read the voltage and current readbacks (for more information see the Bias Voltage Commands section).

The “ON” LED placed on the front panel acts as a status indicator for the bias voltage source: it turns on when the output is enabled and it turns off as soon the output voltage returns to zero and the output is disabled.

The bias voltage source has also an over current protection feature. When the output current reaches the maximum allowed output current, the “OVC” LED placed on the front panel turns on and the bias voltage output is automatically disabled.

The LV bipolar bias, when OFF, shortens the output to the TetrAMM ground while the HV bias, when OFF, goes into high-impedance state.

## 1.5 Data Format

Acquired data from the TetrAMM unit can be configured to be transmitted in two different formats, depending on status of ASCII Command. ASCII commands allow user to choose between ASCII data format, which is readable by humans, and raw floating-point numbers in double precision format (IEEE 754) that are faster to process, they are more accurate and have less overhead during the transmission. For more information about the data transfer see the Acquisition Commands descriptions.

## 1.6 Sampling Frequency

Internal sampling frequency for each channel is **fixed to 100 kHz** – i.e. 100 ksps. In the standard operation modes (ACQ, GET, NAQ and TRG Commands – see Acquisition Commands section) an averaging of the sampled data is performed to reduce the transmission data rate (due to the bottleneck caused by the communication link). Furthermore, the averaging also reduces high frequency noise and increases the signal-to-noise ratio.

In addition to the standard operation mode, it is also possible to sample a smaller window of data at the maximum sampling frequency without performing averaging (for more information see FASTNAQ Command).

## 1.7 Offset Calibration

The TetrAMM device is already factory-calibrated during the production process. However, user can perform an additional calibration – i.e. User Defined Calibration – perhaps nulling application specific offsets – e.g. dark currents in quadrature photodiode detecting systems.

### 1.7.1 User Defined Calibration

As previously cited, the TetrAMM device has the capability of handling user-defined linear calibration parameters on each channel in order to obtain the desired response from the unit. This process can be done, for example, when installing the TetrAMM as the readout device for a photodiode-type detector and it is useful to get automatically rid of the measured dark currents on each channel.

The equivalent current read, by considering the user calibration, it is computed as follows:

$$I_{READ} = Gain_{UD} \cdot I_{raw} + Offset_{UD}$$

where:

- $I_{READ}$  is the user-calibrated current read from the single channel [A];
- $Gain_{UD}$  is the user-defined gain factor [A/A];
- $I_{raw}$  is the raw current read of the device [A];
- $Offset_{UD}$  is the user-defined offset value [A].

The user can enable or disable (as it can also read/write) this calibration values with the specific USRCORR Command. These calibration values are stored internally in a non-volatile memory so that it is possible to recall them at any time, also after a power-cycle of the device.

## 1.8 Ordering Codes

The TetrAMM unit has several options available, listed below:

Ordering Code	Ranges	BIAS	BW	Description
WTETRAMMNOHV	$\pm 120 \mu\text{A}$ $\pm 120 \text{nA}$	/	4 kHz	4-channel Fast Interface Bipolar Picoammeter without Integrated HV Source
WTETRAMM05PX	$\pm 120 \mu\text{A}$ $\pm 120 \text{nA}$	+ 500V	4 kHz	4-channel Fast Interface Bipolar Picoammeter with Integrated +500V HV Source
WTETRAMM05NX	$\pm 120 \mu\text{A}$ $\pm 120 \text{nA}$	- 500V	4 kHz	4-channel Fast Interface Bipolar Picoammeter with Integrated -500V HV Source
WTETRAMM20PX	$\pm 120 \mu\text{A}$ $\pm 120 \text{nA}$	+ 2kV	4 kHz	4-channel Fast Interface Bipolar Picoammeter with Integrated +2kV HV Source
WTETRAMM20NX	$\pm 120 \mu\text{A}$ $\pm 120 \text{nA}$	- 2kV	4 kHz	4-channel Fast Interface Bipolar Picoammeter with Integrated -2kV HV Source
WTETRAMM40PX	$\pm 120 \mu\text{A}$ $\pm 120 \text{nA}$	+ 4kV	4 kHz	4-channel Fast Interface Bipolar Picoammeter with Integrated +4kV HV Source
WTETRAMM40NX	$\pm 120 \mu\text{A}$ $\pm 120 \text{nA}$	- 4kV	4 kHz	4-channel Fast Interface Bipolar Picoammeter with Integrated -4kV HV Source
WTETRAMMC001	$\pm 1.2 \mu\text{A}$ $\pm 1.2 \text{nA}$	- 500V	100 Hz	4-channel Picoammeter with Integrated -500V HV (RNG: $\pm 1.2 \mu\text{A}$ , $\pm 1.2 \text{nA}$ , BW = 100 Hz)
WTETRAMMC002	$\pm 1.2 \text{mA}$ $\pm 1.2 \mu\text{A}$	+ 500V	5 kHz	4-channel Picoammeter with Integrated +500V HV (RNG: $\pm 1.2 \text{mA}$ , $\pm 1.2 \mu\text{A}$ )
WTETRAMMC003	$\pm 25 \mu\text{A}$ $\pm 250 \text{nA}$	/	5 kHz	4-channel Picoammeter without Integrated HV (RNG: $\pm 25 \mu\text{A}$ , $\pm 250 \text{nA}$ )
WTETRAMMC004	$\pm 120 \mu\text{A}$ $\pm 120 \text{nA}$	+ 500V	20 kHz >5 kHz	4-channel Picoammeter with Integrated +500V HV (RNG: $\pm 120 \mu\text{A}$ BW=20 kHz, $\pm 120 \text{nA}$ BW>5 kHz)
WTETRAMMC005	$\pm 10 \mu\text{A}$ $\pm 125 \text{nA}$	- 500V	5 kHz	4-channel Picoammeter with Integrated -500V HV (RNG: $\pm 10 \mu\text{A}$ , $\pm 125 \text{nA}$ )
WTETRAMMC006	$\pm 10 \mu\text{A}$ $\pm 2 \mu\text{A}$	/	5 kHz	4-channel Picoammeter without Integrated HV (RNG: $\pm 10 \mu\text{A}$ , $\pm 2 \mu\text{A}$ )
WTETRAMMC008	$\pm 6 \text{mA}$ $\pm 20 \mu\text{A}$	+ 500V	2 kHz 1 kHz	4-channel Picoammeter with Integrated +500V HV (RNG: $\pm 6 \text{mA}$ BW=2 kHz, $\pm 20 \mu\text{A}$ BW=1 kHz)
WTETRAMMC009	$\pm 20 \mu\text{A}$ $\pm 2 \mu\text{A}$	$\pm 30 \text{V}$	1 kHz	4-channel Picoammeter with Integrated +500V HV (RNG: $\pm 20 \mu\text{A}$ , $\pm 2 \mu\text{A}$ , BW = 1 kHz)
WTETRAMMC010	$\pm 120 \mu\text{A}$ $\pm 120 \text{nA}$	$\pm 30 \text{V}$	20 kHz >5 kHz	4-channel Picoammeter with Integrated $\pm 30\text{V}$ bias (RNG: $\pm 120 \mu\text{A}$ BW=20 kHz, $\pm 120 \text{nA}$ BW>5 kHz)

WTETRAMMC011	$\pm 1.2 \text{ mA}$ $\pm 1.2 \text{ }\mu\text{A}$	$\pm 30 \text{ V}$	20 kHz	4-channel Picoammeter with Integrated $\pm 30\text{V}$ bias (RNG: $\pm 1.2 \text{ mA}$ , $\pm 1.2 \text{ }\mu\text{A}$ , $BW = 20 \text{ kHz}$ )
WTETRAMMC012	$\pm 60 \text{ }\mu\text{A}$ $\pm 15 \text{ }\mu\text{A}$	$\pm 30 \text{ V}$	1 kHz	4-channel Picoammeter with Integrated $\pm 30\text{V}$ bias (RNG: $\pm 60 \text{ }\mu\text{A}$ , $\pm 15 \text{ }\mu\text{A}$ , $BW = 1 \text{ kHz}$ )
WTETRAMMC013	$\pm 1.2 \text{ mA}$ $\pm 1.2 \text{ }\mu\text{A}$	- 500 V	5 kHz	4-channel Picoammeter with Integrated -500V HV (RNG: $\pm 1.2 \text{ mA}$ , $\pm 1.2 \text{ }\mu\text{A}$ , $BW = 5 \text{ kHz}$ )
WTETRAMMCAPS	$\pm 60 \text{ }\mu\text{A}$ $\pm 15 \text{ }\mu\text{A}$	$\pm 5 \text{ V}$	1 kHz	4-channel Picoammeter with Integrated $\pm 6\text{V}$ bias (RNG: $\pm 60 \text{ }\mu\text{A}$ , $\pm 15 \text{ }\mu\text{A}$ , $BW = 1 \text{ kHz}$ )
WTETRAMMC014	$\pm 2 \text{ mA}$ $\pm 50 \text{ }\mu\text{A}$	$\pm 30 \text{ V}$	5 kHz	4-channel Picoammeter with Integrated $\pm 30\text{V}$ bias (RNG: $\pm 2 \text{ mA}$ , $\pm 50 \text{ }\mu\text{A}$ , $BW = 5 \text{ kHz}$ )
WTETRAMMC015	$\pm 1.2 \text{ }\mu\text{A}$ $\pm 1.2 \text{ nA}$	$\pm 30 \text{ V}$	100 Hz	4-channel Picoammeter with Integrated $\pm 30\text{V}$ bias (RNG: $\pm 1.2 \text{ }\mu\text{A}$ , $\pm 1.2 \text{ nA}$ , $BW = 100 \text{ Hz}$ )
WTETRAMMC016	$\pm 12 \text{ mA}$ $\pm 12 \text{ }\mu\text{A}$	$\pm 30 \text{ V}$	20 kHz	4-channel Picoammeter with Integrated $\pm 30 \text{ V}$ (RNG: $\pm 12 \text{ mA}$ , $\pm 12 \text{ }\mu\text{A}$ , $BW=20 \text{ kHz}$ )
WTETRAMMC017	$\pm 1.2 \text{ }\mu\text{A}$ $\pm 1.2 \text{ nA}$	/	100 Hz	4-channel Picoammeter without Integrated Bias (RNG: $\pm 1.2 \text{ }\mu\text{A}$ , $\pm 1.2 \text{ nA}$ , $BW = 100 \text{ Hz}$ )
WTETRAMMC018	$\pm 1.2 \text{ }\mu\text{A}$ $\pm 1.2 \text{ nA}$	+500 V	100 Hz	4-channel Picoammeter with Integrated +500 HV (RNG: $\pm 1.2 \text{ }\mu\text{A}$ , $\pm 1.2 \text{ nA}$ , $BW = 100 \text{ Hz}$ )
WTETRAMMC019	$\pm 120 \text{ }\mu\text{A}$ $\pm 120 \text{ nA}$	/	1 kHz	4-channel Picoammeter without Integrated Bias (RNG: $\pm 120 \text{ }\mu\text{A}$ , $\pm 120 \text{ nA}$ , $BW=1 \text{ kHz}$ )
WTETRAMMC020	$\pm 1.6 \text{ }\mu\text{A}$ $\pm 120 \text{ nA}$	$\pm 30 \text{ V}$	1 kHz	4-channel Picoammeter with Integrated $\pm 30 \text{ V}$ bias (RNG: $\pm 1.6 \text{ }\mu\text{A}$ , $\pm 120 \text{ nA}$ , $BW=1 \text{ kHz}$ )
WTETRAMMC021	$\pm 5 \text{ }\mu\text{A}$ $\pm 5 \text{ nA}$	$\pm 30 \text{ V}$	500 Hz	4-channel Picoammeter with Integrated $\pm 30 \text{ V}$ bias (RNG: $\pm 5 \text{ }\mu\text{A}$ , $\pm 5 \text{ nA}$ , $BW=500 \text{ Hz}$ )

## 2. Software Commands

This chapter describes the software commands used for the correct configuring of the TetrAMM picoammeter and for its data readout. For more information about the Ethernet settings see the Ethernet Communication chapter.

### 2.1 Command Syntax

The command syntax used by the TetrAMM protocol is described in the following sections.

Commands must be sent in ASCII format and are composed by a “*command field*” and one, two or none “*parameter field*”, separated by a colon (‘:’ or ‘0x3A’ in hexadecimal notation). The number of “*parameter fields*” depends on the specific command. Commands are **NOT case sensitive** and therefore the command string can be sent either using uppercase or lowercase characters (conversion to uppercase characters is performed internally). Each instruction must be terminated with a ‘*carriage return\line feed*’ sequence ‘`\r\n`’ (or ‘0x0D 0x0A’ in hexadecimal notation or commonly CRLF).

#### Command Example:

***RNG:1\r\n***

- “***RNG***” is the command field;
- ‘:’ is the parameter’s separation character;
- ‘***1***’ is the first parameter field;
- ‘***\r\n***’ are the termination sequence of the command.

Commands are processed one at a time; therefore, user must wait for a response from the unit before sending the next command. All the responses from the TetrAMM device are in upper case and are terminated with the same ‘*carriage return\line feed*’ sequence (‘`\r\n`’) – i.e. CRLF – used in the command.

The reply from the device depends on the given command; for more information about the single command please refer to the specific command section.

There are two specific replies that are commonly used in many commands, and that indicate that the command has been correctly elaborated or not. Those replies are hereafter presented:

- **ACK**nowledge (‘**ACK**’) indicates that the command is valid and it was correctly elaborated by the device:

*ACK\r\n*

- “*ACK*” is the **ACK**nowledged response to a valid command;
  - ‘*\r\n*’ is the termination sequence of the reply.
- **Not AcK**nowledge (‘**NAK**’) indicates that the command is either not valid or that it was not accepted by the device; the “*NAK*” reply is followed by an “*error code*” field, which can be used to determine the cause of the error (see the List of the Error Codes appendix for a detailed list of all possible error codes):

*NAK:01\r\n*

- “*NAK*” is the **Not AcK**nowledged response to an invalid command;
- ‘:’ is the parameter’s separation character;
- ‘*01*’ is a sample error code;
- ‘*\r\n*’ is the termination sequence of the reply.

The list of commands used by the TetrAMM and the corresponding syntax is hereafter presented as well as a description of each command purpose and any special requirements related to the specific command. The commands are hereafter described and are grouped in categories based on their purpose.

## 2.2 Acquisition Commands

The Acquisition commands are used to acquire data of the measured currents present on the input channels of the TetrAMM device. The internal sampling frequency for each channel, as previously stated, is fixed to 100 kHz (sampling period of 10 μs) but for standard acquisition modes (ACQ Command, GET Command, NAQ Command and TRG Command) an averaging of these full-speed sampled data is performed in order to reduce the required data rate to be transmitted which is limited due to the communication link limitations.

In addition to the standard modes there is also a full-speed acquisition mode (FASTNAQ Command), which allows users to acquire the data at the maximum data rate of 100 kHz (the same as the internal sampling frequency – i.e. without any performed averaging) on a smaller time window.

The mentioned acquisition modes are presented in the following sections.

## 2.2.1 ACQ Command

The ACQ commands starts or stops the data acquisition from the TetrAMM device. The instrument starts to acquire data at its maximum sampling frequency as soon as the command is received and it immediately sends the generated digital data stream to the connected host PC. A command has to be sent in order to stop the data acquisition.

The acquisition is stopped at power-up (*default*); the user is then required to start the data acquisition by sending the “ACQ:ON\r\n” command to the TetrAMM in order to start the data conversion and transmission. When the command is correctly processed, the unit starts to acquire samples and it continuously sends the acquired data to the connected host; if the command is not accepted, the unit replies with a “NAK:xx\r\n” string, where the *xx* field indicates the error code (see the List of the Error Codes appendix)

To stop the data acquisition the user has to send the “ACQ:OFF\r\n” command to the TetrAMM unit. The unit replies with an acknowledge (“ACK\r\n”) string as soon as an “ACQ:OFF\r\n” command is received.

Command	Command description
ACQ:ON\r\n	Start continuously sampling
ACQ:OFF\r\n	Stop sampling

The transmitted data format (to the host PC) depends on the setting of the “ASCII mode” (see ASCII Command section) and the number of activated channels (see the CHN Command section). The purpose of the number of activated channels is to define the number of simultaneously sampled channels. The ASCII command changes the format of the digital stream generated by the TetrAMM unit. Two possible sample representations are available on the TetrAMM device:

- if ASCII mode is **enabled**, the output stream is displayed in ASCII format so that the user can directly read the acquired data. This data stream is represented as strings in normalized scientific notation with a fixed length;
- if ASCII mode is **disabled**, the output stream is displayed in binary format (the user can not directly read the acquired data since they are represented in binary standard, used in information technology - this is the double precision floating-point - IEEE 754 standard – 64 bits).

Example of a single acquisition on 4 channels with ASCII data stream enabled (data are represented as a string in normalized scientific notation with fixed length; non-printing characters are displayed in red - each channel value is separated by a tab character ‘\t’ and each acquisition is terminated with two termination characters: carriage return/line feed ‘\r\n’):



As an example, a single acquisition on 4 channels in ASCII format takes 15 characters for each channel (this implies a total of 60 characters for 4-channel acquisition) and 5 characters for delimitation tabs and termination characters; the total number of bytes to be transferred is then of 65 – i.e. 65 characters.

On the other hand, if a raw binary transfer (i.e. ASCII mode disabled) is used, the double precision floating number - 64 bits - 8 bytes for each channel and a custom *sNaN* termination needs to be transferred, for a total amount of 40 bytes (5 numbers) in a 4-channel acquisition. The data to be transmitted in this particular situation is then almost 40% less using raw binary data than using ASCII strings.

The maximum data rate transfer limit in the two configurations is:

- 200 acquisitions-per-second (200 Hz) when ASCII format is enabled;
- 20.000 acquisitions-per-second (20 kHz) when ASCII format is disabled.

In both cases internal sampling frequency of the ADCs remains untouched to 100 kHz, but in order to reduce the amount of data to be transmitted to the host PC, the samples are averaged and normalized. The normalized averaging is made on 500 samples in the case of ASCII mode and on only 5 samples in binary format.

Please note that the number of sampled channels (CHN setting) do not affect the data transfer rate limit.

The maximum data rates and the number of averaged samples are indicated in the following table:

Data format	ACQ maximum data rate	Averaged samples @ 100 kHz
ASCII enabled ( <b>string</b> format)	200 Hz	500 (min value)
ASCII disabled ( <b>binary</b> format)	20.000 Hz	5 (min value)

The TetrAMM unit allows also to additionally decrease the acquisition transfer rate using the NRSAMP command (see the NRSAMP Command section), which allows to calculate a normalized averaging on a larger number of samples.

It is also possible to increment the acquisition data rate up to a value equal to the ADC internal sampling frequency (i.e. 100 kHz); the acquisition in this case cannot be continuous as when using the ACQ command and thus only time frames (limited time windows) can be acquired.

The use of this particular feature is carried out using the FASTNAQ command (see FASTNAQ Command section).

**Examples:**

*ACQ ON example with ASCII data on 2 channels (the following data are represented in string format):*

```

ACQ:ON\r\n →
← +1.12345678E-12\t +1.12345680E-12\r\n
← +1.12345670E-12\t +1.12345685E-12\r\n
← +1.12345682E-12\t +1.12345698E-12\r\n
← ..... \r\n
    
```

*ACQ OFF example with ASCII data on 2 channels:*

```

← ..... \r\n
← +1.12345770E-12\t +1.12345680E-12\r\n
← +1.12345782E-12\t +1.12345698E-12\r\n
← +1.12345795E-12\t +1.12345701E-12\r\n
ACQ:OFF\r\n →
← ACK\r\n
    
```

*ACQ ON example with ASCII format disabled on 1 channel (note that following data are represented in hexadecimal format):*

```

ACQ:ON\r\n →
← 3D73C3997B2D31CBFFF40002FFFFFFFF
← 3D74D3997B2D31CBFFF40002FFFFFFFF
← 3D75C3997B2D31CBFFF40002FFFFFFFF
← ..... FFF40002FFFFFFFF
    
```

*ACQ OFF example with ASCII data enabled on 1 channel:*

```

← ..... \r\n
← +1.12345680E-12\r\n
← +1.12345698E-12\r\n
← +1.12345701E-12\r\n
ACQ:OFF\r\n →
← ACK\r\n
    
```



## 2.2.2 GET Command

The purpose of the GET command is to read back a single snapshot of the values for the active channels. The “G\r\n” command is a useful shortcut fully equivalent to the “GET:?\r\n” command.

The format of the returned values is the same as for the ACQ Command and it depends both on the “ASCII mode” settings (refer to ASCII Command) and the active channels settings (see CHN Command section). Please refer to the ACQ Command description for a more accurate explanation of the output stream formatting.

### Examples:

*GET example with ASCII data on 2 channels (the following data are represented in string format):*

G:?\r\n (or) GET:?\r\n → ← +1.12345678E-12\r +1.12345680E-12\r\n

or:

G\r\n (or) GET\r\n → ← +1.12345678E-12\r +1.12345680E-12\r\n

*GET example with ASCII format disabled on 1 channel (note that following data are represented in hexadecimal format):*

GET:?\r\n → ← 3D73C3997B2D31CBFFF40002FFFFFFFF

### 2.2.3 NAQ Command

The purpose of the NAQ command is to read a fixed number of acquisitions, ranging from 1 to 2.000.000.000 (i.e. 2-billion acquisition cycles), without having to manually stop the acquisition when the desired number of samples has been read (unlike with the sole ACQ command without NAQ (default: NAQ = 0)).

As for the ACQ command without NAQ, the format of the returned data stream depends on the “ASCII mode” settings (refer to ASCII Command section) and the active channels settings (see CHN Command section). For a more accurate explanation of the output stream formatting see the ACQ Command description. The TetrAMM unit indicates the end of data transfer with an acknowledgement reply (“ACK\r\n”).

The maximum acquisition data rate is limited due to the to the communication link limitations so that the maximum data rates are the same as for the ACQ command without NAQ (for more information see the ACQ Command section). The data rate could be additionally decreased using the NRSAMP command (refer to the NRSAMP Command), which allows to calculate a normalized averaging on a larger number of samples, thus reducing also the equivalent measuring noise value.

The NAQ command behaves differently when the device is in trigger mode (TRG:ON). For more information, refer to the TRG command section.

#### Examples:

*NAQ example for 3 acquisitions in ASCII on 2 channels (the following data are represented in string format):*

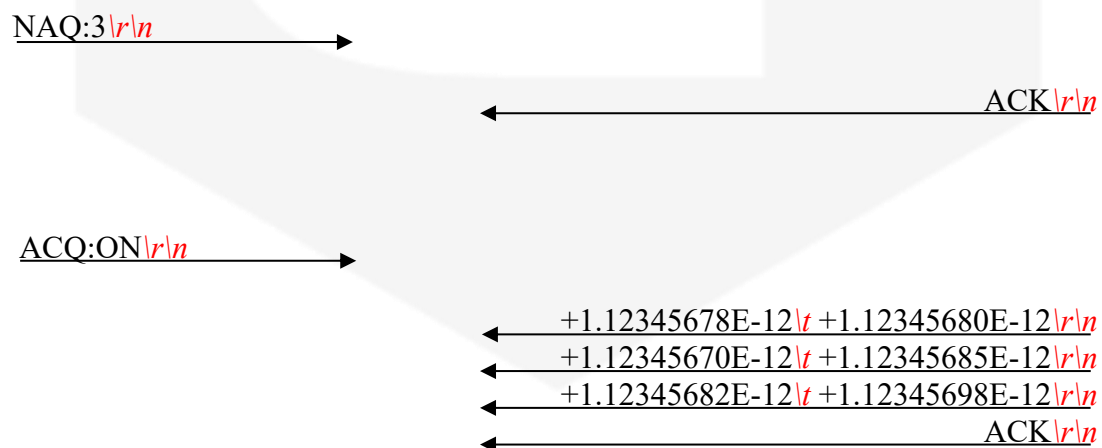

*NAQ example for 5 acquisitions with ASCII format disabled on 1 channel (note that following data are represented in hexadecimal format, note that the last line “41434B0D0A” in hex format is equivalent to “ACK\r\n” in string format):*

NAQ:5\r\n →

← ACK\r\n

ACQ:ON\r\n →

← 3D73C3997B2D31CBFFF40002FFFFFFFF

← 3D74D3997B2D31CBFFF40002FFFFFFFF

← 3D75C4000B2D31CBFFF40002FFFFFFFF

← 3D75C4005B2D31CBFFF40002FFFFFFFF

← 3D75C4080B2D31CBFFF40002FFFFFFFF

← 41434B0D0A



## 2.2.4 TRG Command

The TRG command allows the TetrAMM to synchronize data acquisition with an external event via the hardware “Trigger” input signal (e.g., an experimental time window).

For details on the “Trigger” input connector, refer to the Triggers Connectors section.

The “trigger mode” operation is described below.

### Enabling Trigger Mode

The trigger mode is enabled with a “TRG:ON\r\n” command, to which the TetrAMM unit replies with an “ACK\r\n”.

Once trigger mode is enabled, the user must start acquisition with: “ACQ:ON\r\n” command. In this configuration, the unit will start to send acquired data after the trigger signal is detected.

The signal level polarity can be set by the TRGPOL command. The default configuration is TRGPOL:POS.

### Trigger modes

The TetrAMM supports two trigger modes, selected by the value of **NAQ** (default: NAQ = 0):

Trigger mode	NAQ Value
Gate	0
Count	> 0

Data acquisition behavior depends on **NAQ** and **NTRG**.

### Gate Mode (NAQ = 0)

When NAQ = 0 and trigger mode is enabled (“TRG:ON”):

- Acquisition begins on the **rising edge** (default) of the “Trigger” input signal.
- Data is continuously processed (with normalized averaging due to communication limits) and sent to the host **as long as the “Trigger” input remains high**.
- Acquisition stops on the **falling edge** (default) of the Trigger input.

This cycle repeats:

- **NTRG times** if NTRG > 0, or
- **indefinitely**, until acquisition is stopped manually with: “ACQ:OFF\r\n”

## Count Mode (NAQ > 0)

When NAQ > 0 and trigger mode is enabled (“TRG:ON\r\n”):

- Acquisition begins on the **rising edge** (default) of the “Trigger” input.
- The falling edge of the Trigger input **does not stop** acquisition.
- The TetrAMM sends averaged data to the host every time it acquires NRSAMP samples.
- Acquisition stops when a total of NRSAMP × NAQ samples have been collected.
- Acquisition stays on hold until the **next complete trigger cycle** (falling edge followed by a rising edge) occurs on the “Trigger” input

This sequence repeats:

- **NTRG times** if NTRG > 0, or
- **indefinitely**, until the user stops acquisition with: “ACQ:OFF\r\n”

## Trigger frequency limit

In addition to the standard output data rate, the trigger mode adds 1 more constrain:

$$\text{Acquisition frequency} = \min(f(\text{trigger}), f(\text{averaged data})) \leq 2 \text{ kHz}$$

**Exceeding this limit may cause errors in packet generation. This limit has been verified on a point-to-point network (TetrAMM directly connected to a PC). For more complex networks the limit may be different.**

*Examples:*

#	f(trigger)	f(avg data)	Acquisition frequency	Limit	Status
1	2 kHz	1 kHz	1 kHz	under	OK
2	10 kHz	1 kHz	1 kHz	under	OK
3	2 kHz	2 kHz	2 kHz	under	OK
4	2 kHz	10 kHz	2 kHz	under	OK
5	1 kHz	10 kHz	1 kHz	under	OK
6	5 kHz	10 kHz	5 kHz	over	ERROR
7	10 kHz	5 kHz	5 kHz	over	ERROR

## Output data stream

In addition to the standard output data stream, the trigger mode adds a header and a footer to the acquired data.

The header indicates a sequence number (i.e. counter) of the trigger events, starting with #0. The sequence number is reset when the “trigger mode” is disabled. The header format also depends on the ASCII mode and the number of activated channels:

- ASCII mode enabled: the header has the following format: “SEQNR:*n*\r\n”, where *n* is the sequence number of trigger event in decimal representation;
- ASCII mode disabled: the header format depends on the number of activated channels - it is composed of a 64-bit Signaling Not a Number *sNaN* (“Sequence Number *sNaN*”) IEEE 754 - double precision floating point. This particular value is composed by two parts: the most significant 32 bits are constant (0xFFF40000) and the lower 32 bits indicates the sequence number in hexadecimal format (for example the sequence number 161 is represented as 0x000000A1, so the entire *sNaN* is displayed as 0xFFF40000 000000A1). In order to maintain the format of the transmitted data stream, the *sNaN* value is repeated *k* times, where *k* is the number of active channels and the header is terminated with a custom “Start Trigger” *sNaN* (0xFFF40000 FFFFFFFF) – used to indicate the start of data acquisition. As an example, the header of a 2-channel acquisition with ASCII mode disabled for a sequence number of 161 is displayed as:

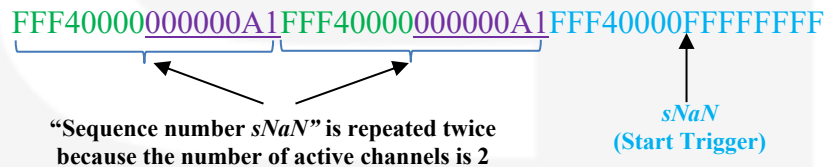

The footer appended to the transferred data indicates the end of trigger event. The footer format depends on the ASCII setting:

- ASCII mode enabled: the footer has the following form: “EOTRG\r\n” (End Of TRiGger);
- ASCII mode disabled: the footer is composed by the following fixed *sNaN*, called “End of trigger event *sNaN*” 64-bit sequence 0xFFF4 0001 FFFF FFFF. In order to maintain the format of the transmitted data stream, the *sNaN* value is repeated *k* + 1 times, where *k* is the number of active channels.

**Examples:**

TRG example with ASCII mode enabled on a 2-channel acquisition (the following data are represented in string format):

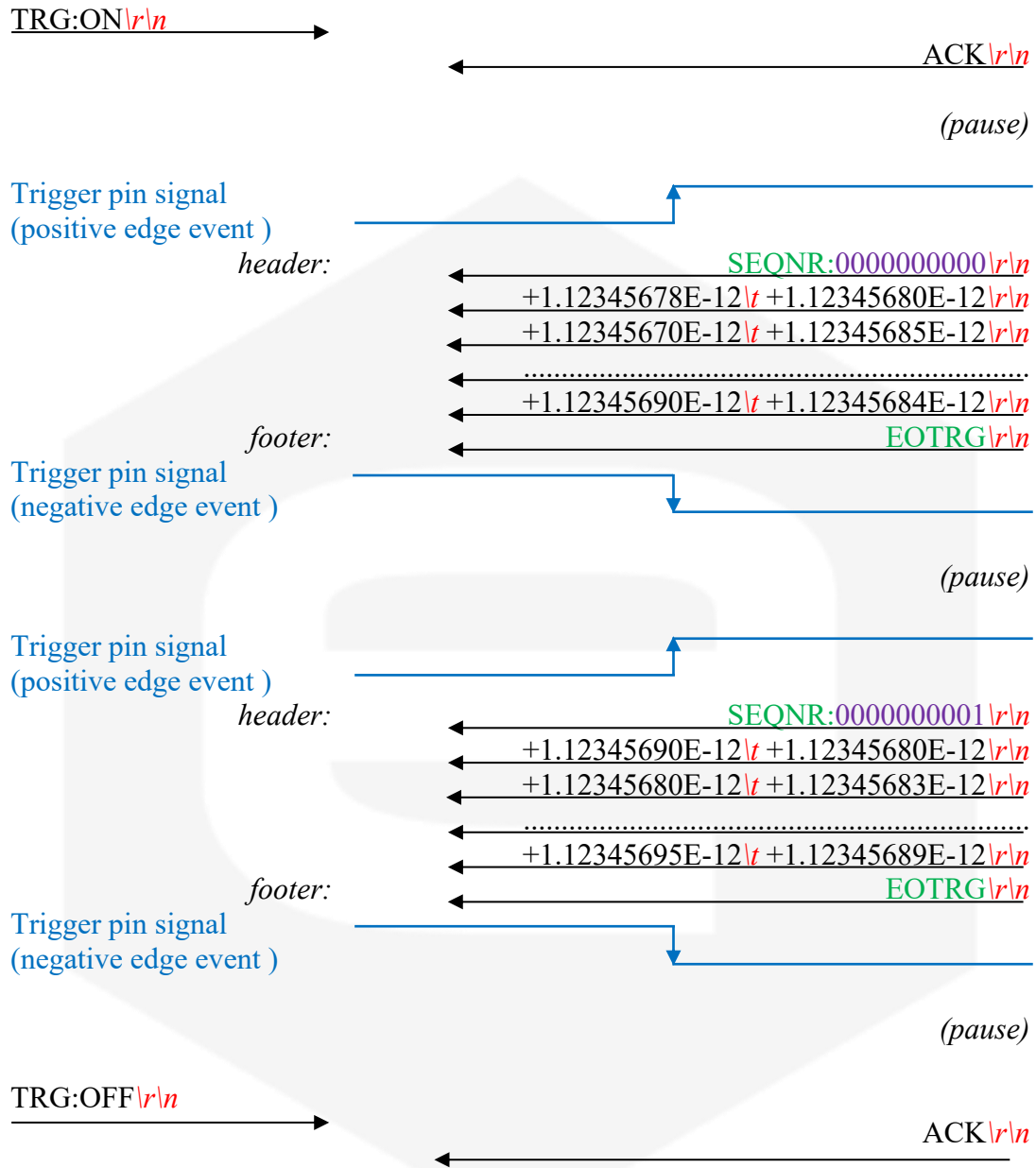

TRG example with ASCII mode disabled on 2-channel acquisition (the following data are represented in hexadecimal format):

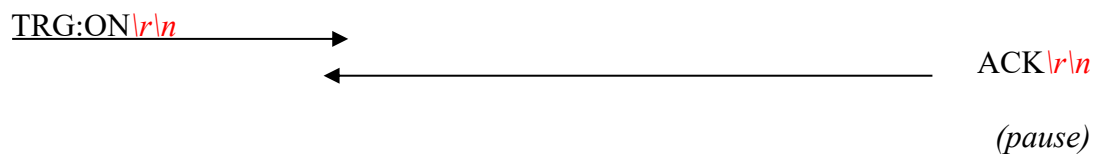

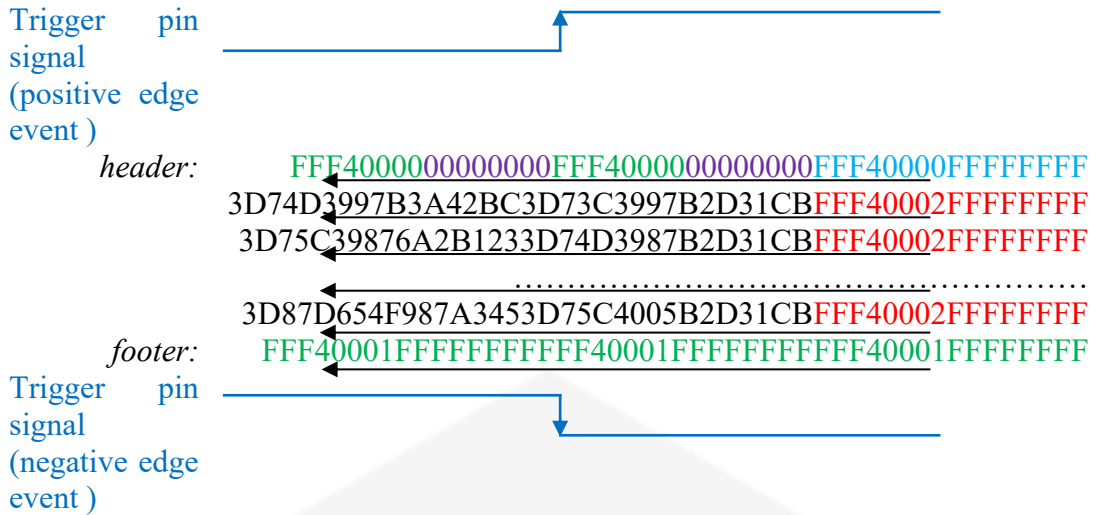

(pause)

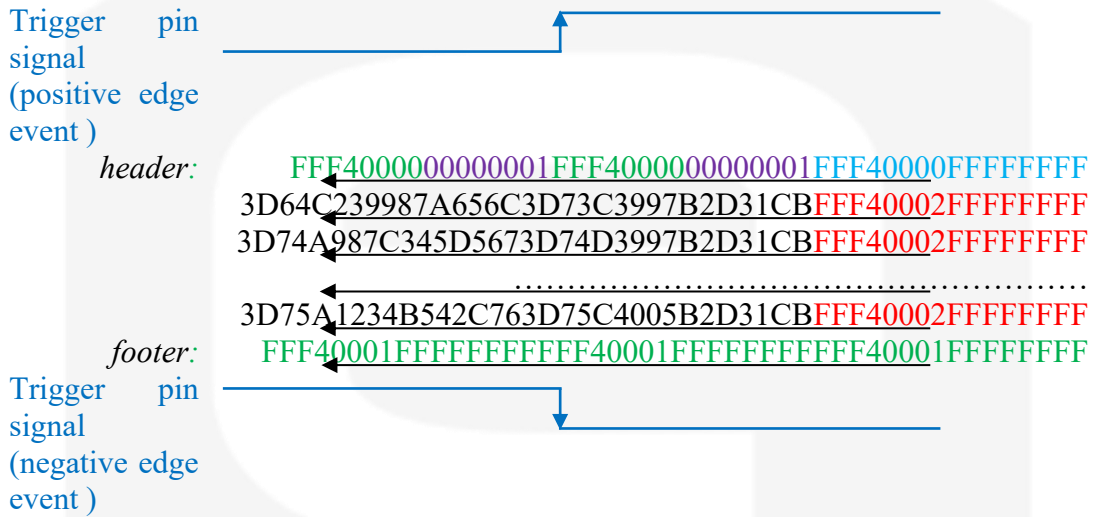

(pause)

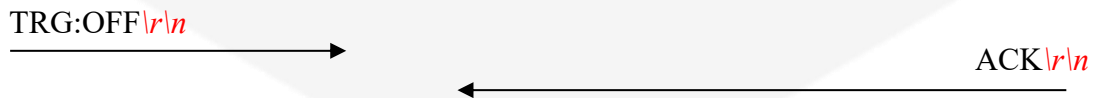

## 2.2.5 FASTNAQ Command

The FASTNAQ command is used to use the fast acquisition capabilities of the TetrAMM unit – i.e. to acquire a limited number of samples at the maximum sampling frequency of 100 kHz. The acquired samples are stored on the internal memory and they are later transmitted to the host. The maximum number of acquired samples is limited by the internal memory size, so that the window size is larger if the acquisition has to be performed on a smaller number of channels (see CHN Command section) but it is independent from the data format (ASCII or binary data).

Number of Channels	Maximum Number of Samples	Maximum Time-window Size
1	1,048,576	10,48576 seconds
2	699,050	6,99050 seconds
4	419,430	4,19430 seconds

Obviously, the averaging of the acquired samples is not possible using this command so that the NRSAMP setting is ignored (see NRSAMP Command section).

The command to be set in order to start a fast acquisition is “FASTNAQ:*n*\r\n”, where *n* is the number of samples to be acquired for each channel. The output data format depends on the setting of the “ASCII mode” (refer to the ASCII Command section) and the number of channels to be acquired (refer to the CHN Command section). To get a more accurate description of the output stream please refer to the ACQ Command section.

Note that, while in the ACQ command procedure the ASCII setting limits the acquisition time, in the FASTNAQ acquisition the ASCII setting does not affect the acquisition speed but it influences only the data transmission speed.

The unit indicates the end of data transfer by sending an acknowledgement reply (“ACK\r\n” in ASCII mode).

### Examples:

*FASTNAQ example for 3 acquisitions with ASCII mode enabled on 2 channels (the following data are represented in string format):*

```
FASTNAQ:3\r\n →
← +1.12345678E-12\t +1.12345680E-12\r\n
← +1.12345670E-12\t +1.12345685E-12\r\n
← +1.12345682E-12\t +1.12345698E-12\r\n
← ACK\r\n
```

*FASTNAQ example for 5 acquisitions with ASCII format disabled on 1 channel (note that following data are represented in hexadecimal format, note that the last line “41434B0D0A” in hex format is equivalent to “ACK\r\n” in string):*

```
FASTNAQ:5\r\n →
← 3D73C3997B2D31CBFFF40002FFFFFFFF
← 3D74D3997B2D31CBFFF40002FFFFFFFF
← 3D75C4000B2D31CBFFF40002FFFFFFFF
← 3D75C4005B2D31CBFFF40002FFFFFFFF
← 3D75C4080B2D31CBFFF40002FFFFFFFF
← 41434B0D0A
```

## 2.3 Configuration Commands

The commands that can be used to set or to read the TetrAMM device configuration are described in this section.

### 2.3.1 IFCONFIG Command

After an IFCONFIG command, the module will reply with its current network configuration as it is shown below:

```
IFCONFIG\r\n →
← MAC: ... \r\n
← IP address: ... \r\n
← Netmask: ... \r\n
← Gateway: ... \r\n
← Rx bytes: ..., Tx bytes: ... \r\n
← Errors: ... \r\n
```

### 2.3.2 HELP Command

The HELP command is used to print the list of commands of the TetrAMM module. The same reply is also given by the “?\r\n” command.

HELP\r\n (or) ?\r\n →

← S	Stops current acquisition\r\n
← GET	Gets single reading \r\n
← ...	...
← ?	Displays commands r\n

### 2.3.3 CHN Command

The purpose of the CHN command is to set the number of active input channels that have to be sampled; the TetrAMM provides the capability to simultaneously sample 1, 2 or 4 channels. The number of sampled channels does not affect the internal sampling frequency (that remains 100 kHz). The default number of sampled channels is four (4).

The sampled channels and the relative CHN command are shown in the following table:

Command	Sampled Channels
CHN:1\r\n	CH1
CHN:2\r\n	CH1, CH2
CHN:4\r\n	CH1, CH2, CH3, CH4

The command used to read the actual CHN setting is: “CHN:?\r\n”. The reply to the read command is in the following form: “CHN:sampled\_chn\r\n”, where *sampled\_chn* could be ‘1’, ‘2’ or ‘4’.

#### Examples:

CHN set example:

CHN:4\r\n →

← ACK\r\n

CHN set example with incorrect parameter:

CHN:3\r\n → ← NAK:02\r\n

CHN read example:

CHN:?\r\n → ← CHN:4\r\n

### 2.3.4 ASCII Command

The purpose of the ASCII command is to change the format of the digital data stream generated by the TetrAMM unit. There are two possible stream settings that can be configured:

Command	Generated stream
ASCII:ON\r\n	Output values are sent as strings in normalized scientific notation with a fixed length
ASCII:OFF\r\n	Output values are sent as double precision floating point values (IEEE 754 standard – 64 bits)

With the “ASCII:ON\r\n” command the ASCII format is enabled and the output values are sent as a string in a normalized scientific notation. An example of used notation is as follow:

+1.12345678E-12  
 $\underbrace{\hspace{1.5cm}}_a \quad \underbrace{\hspace{0.5cm}}_b$

where the exponent  $b$  is chosen so that the absolute value of  $a$  is included between one and ten ( $1 \leq |a| < 10$ ). The total length of the string is fixed to 15 characters (15 bytes), so that, as an example, the number -10.1 is displayed as:

-1.01000000E+01  
 $\underbrace{\hspace{1.5cm}}_a \quad \underbrace{\hspace{0.5cm}}_b$

The double precision floating point representation (“ASCII:OFF\r\n” setting) improves the data rate transmission as it avoids the overhead due to the ASCII format conversation and reduces the amount of sent data. The structure of each 64-bit (8 bytes) double precision number is as follows:

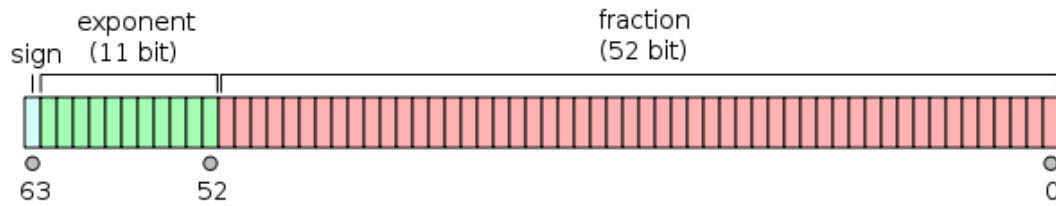

so that each number is represented as a combination of the following data fields:

- **bit #63** - “sign” bit;
- **bits #62-52** (11 bits) - “exponent” bits;
- **bits #51-0** (52 bits) - “significant” or “mantissa” bits.

For default the ASCII mode is disabled – data are represented in the double precision floating point format. In order to have some examples on the generated output stream, please see Acquisition Commands section.

The user can use the command “ASCII:?\r\n” in order to read the actual ASCII setting; the replies to the read command are in the format “ASCII:mode\r\n”, where *mode* could be ON or OFF.

### Examples:

*ASCII set example:*

ASCII:ON\r\n → ← ACK\r\n

*ASCII set example with incorrect parameter:*

ASCII:XX\r\n → ← NAK:04\r\n

*ASCII read example:*

ASCII:?\r\n → ← ASCII:OFF\r\n

### 2.3.5 RNG Command

The purpose of the RNG command is to set the gain and therefore the full-scale range of the TetrAMM. The TetrAMM unit can operate in two possible ranges (the following ranges are shown as an example but it depends on the specific TetrAMM ranges):

	Full Scale	Resolution@24 bit
Range 0	$\pm 120 \mu\text{A}$	15 pA
Range 1	$\pm 120 \text{nA}$	15 fA

The full-scale range can be set to all four channels simultaneously using the command “RNG:parameter\r\n”, where the *parameter* could be:

- ‘0’ to set the range to  $\pm 120 \mu\text{A}$  full-scale value on all 4 channels;
- ‘1’ to set the range to  $\pm 120 \text{nA}$  full-scale value on all 4 channels;
- ‘AUTO’ to enable the automatic range selection (in this case one of the two available ranges is automatically selected evaluating the input values for each individual channel). The active range can be different among channels.

When the automatic range selection is enabled, the TetrAMM unit determines the most suitable range for each individual channel using the following logic:

- if the channel range is set to ‘0’ ( $\pm 120 \mu\text{A}$  full-scale value) and the input current absolute value drops below  $90 \text{nA}$  for at least a 1-second period, the range is automatically changed to the narrower range ‘1’ ( $\pm 120 \text{nA}$  full-scale value);
- if the channel range is set to ‘1’ ( $\pm 120 \text{nA}$  full-scale value) and the input current absolute value exceeds  $110 \text{nA}$  for at least a  $100\text{-}\mu\text{s}$  period, the range is automatically changed to the wider range ‘0’ ( $\pm 120 \mu\text{A}$  full-scale value),

Few samples are corrupted during the range change as internal switches are opened/closed; these corrupted samples are not cancelled from the data stream in order to maintain equal period between samples.

At power-up the TetrAMM range is set to its higher current full-scale range (0, *default*) in order to avoid possible damages to the device in case some of its inputs are connected to a high current source/sink at startup.

Ranges could also be set on each channel independently, thus allowing inputs to have different full-scale ranges. The command to set the channel range to a single channel is “RNG:CHx:parameter\r\n”, where *x* is the channel number, ranging from ‘1’ to ‘4’ and *parameter* is the selected range that could be ‘0’, ‘1’ or ‘AUTO’. The meaning of the parameter field is the same as previous.

To read the actual RNG setting simultaneously on all 4 channels, it is possible to use the command “RNG:?\r\n”. The answer on that read command when all four channels have the same setting is “RNG:mode\r\n”, where *mode* could be ‘0’, ‘1’ or ‘AUTO’. When channels ranges are not equal to each other, the response is slightly different. In that case the TetrAMM unit response with four *mode* fields separated by character ‘:’, representing setting for each individual channel – so the response is in the following form: “RNG:mode:mode:mode:mode\r\n”.

It is also possible to read the individual channel RNG setting. In that case the read command is: “RNG: CHx:?\r\n”, where *x* is the number of the channel from ‘1’ to ‘4’. The response on that command is “RNG: CHx:mode\r\n”, always with *x* representing the channel number and *mode* the full range setting.

**Examples:**

*RNG set example (simultaneously sets range ‘1’ (±120 nA) on all 4 channels):*

RNG:1\r\n → ← ACK\r\n

*RNG set example (simultaneously sets automatic range selection on all 4 channels):*

RNG:AUTO\r\n → ← ACK\r\n

*RNG set example (sets only channel #3 to range ‘1’):*

RNG:CH3:1\r\n → ← ACK\r\n

*RNG read example (all 4 channels are set on automatic range selection):*

RNG:?\r\n → ← RNG:AUTO\r\n

*RNG read example (channels ranges are not equal to each other, for example range of ch#1 is set to ‘0’, range of ch#2 and ch#3 to ‘1’ and ch#4 to ‘AUTO’ mode):*

RNG:?\r\n → ← RNG:0:1:1AUTO\r\n

*RNG read example (reads only the ch#2 range setting):*

RNG:CH2:?\r\n → ← RNG:CH2:0\r\n

### 2.3.6 USRCORR Command

The TetrAMM device is already factory-calibrated during the production process. However, user is allowed to set user-defined linear calibration parameters on each channel in order to obtain the desired response from the unit or to null the application-related offsets.

USRCORR Commands allows to enable/disable or to set/read the user-defined gain and offset corrections. If enabled, output values are computed as:

$$I_{READ} = Gain_{UD} \cdot I_{raw} + Offset_{UD}$$

where:

- $I_{READ}$  is the user-calibrated current readback from the single channel [A];
- $Gain_{UD}$  is the user-defined gain factor [A/A];
- $I_{raw}$  is the normal current read of the device [A];
- $Offset_{UD}$  is the user-defined offset value [A].

If disabled,  $Gain_{UD}$  is set to 1 and  $Offset_{UD}$  to 0 (*default* setting) – in this case the user-calibrated readback is the same as the nominal current read of the TetrAMM as

$$I_{READ} = I_{raw}$$

The commands shown in the following table needs to be sent to the device in order to enable or disable the user-correction feature respectively:

Command	Setting
USRCORR:ON\r\n	User correction enabled
USRCORR:OFF\r\n	User correction disabled

The device replies with an acknowledgement string if the command is correctly interpreted. The command “USRCORR:?\r\n” is used to read the actual user-correction setting; replies to this read commands are in the format “USRCORR:mode\r\n”, where *mode* could be ‘ON’ or ‘OFF’.

This command could be also used to set or read the correction gain and offset of each channel and each range - note that the user correction could be different on the two possible ranges and among the various four channels, so there are 8 possible values for gain and 8 possible values for offset.

The command that can be used to set the gain *value* for a specific range *x* of a specific channel *y* is in the format “USRCORR:RNGxCHyGAIN:value\r\n”; please note that *value* is a dimensionless value [A/A].

A similar procedure can be performed in order to set the offset on a specific range of single channel the command “USRCORR:RNGxCHyOFFS:*value*\r\n”; in this particular case *value* is a current value expressed in [A].

An acknowledgement string is returned if any of the previous commands are correctly interpreted.

The user-defined gain and offset values can be read as follows:

- “USRCORR:RNGxCHyGAIN:?\r\n” in order to read the gain correction value on range *x* and channel *y*. The device replies to this command with “USRCORR:RNGxCHyGAIN:*value*\r\n”, where *value* is the applied gain correction to channel *y* on range *x* ;
- “USRCORR:RNGxCHyOFFS:?\r\n” in order to read the offset correction value on range *x* and channel *y*. The device replies to this command with “USRCORR:RNGxCHyOFFS:*value*\r\n”, where *value* is the applied offset correction to channel *y* on range *x* ;

### Examples:

USRCORR set example (enables user correction):

USRCORR:ON\r\n → ACK\r\n

USRCORR read example:

USRCORR:?\r\n → USRCORR:ON\r\n

USRCORR set gain correction on range ‘0’ and channel #2 example:

USRCORR:RNG0CH2GAIN:1.012\r\n → ACK\r\n

USRCORR read offset correction on range ‘1’ and channel #4 example:

USRCORR:RNG1CH4OFFS:?\r\n → USRCORR:RNG1CH4OFFS:0.0158\r\n

### 2.3.7 NRSAMP Command

This command allows to select the number of samples on which averaging is computed. The command has the following format: “NRSAMP: $n$ \r\n”, where  $n$  indicates the number of acquisitions on which the normalized averaging is done, so every transferred acquisition is calculated on  $n$  “real” samples (the internal fixed sampling frequency is 100 kHz). The acquisition frequency  $f_{data\_rate}$  could be calculated as:

$$f_{data\_rate} = \frac{f_{sampling}}{n} = \frac{100 \text{ kHz}}{n}$$

Due to the transferred speed limitations introduced by the communication link it is necessary to limit the data transfer rate for some acquisition modes. The data rate limitations are described in the Acquisition Commands section.

The command format used to read the current setting for averaged samples is “NRSAMP:?\r\n”. The reply to the read command is “NRSAMP: $n$ \r\n”, where  $n$  represents the number of averaged samples; a maximum number of 100.000 internal samples can be averaged in order to obtain a single data sample. Allowed values for NRSAMP are  $5 \leq n \leq 100.000$  if ASCII=OFF (i.e. equivalent sampling period ranging from 50  $\mu$ s to 1 s) or  $500 \leq n \leq 100.000$  if ASCII=ON (i.e. equivalent sampling period ranging from 5 ms to 1 s).

#### Examples:

NRSAMP set example:

NRSAMP:500\r\n → ACK\r\n

NRSAMP invalid set example (the number of averaged samples is not sufficient because of the data transfer limitation):

NRSAMP:1\r\n → NAK:17\r\n

NRSAMP read example:

NRSAMP:?\r\n → NRSAMP:500\r\n

### 2.3.8 STATUS Command

The internal status register of the TetrAMM shows the status of the unit. The status is composed of 6 bytes – i.e. 48 bits – where each byte contains a specific type of information (please note that bit 47 is the MSB and bit 0 is the LSB):

Status Register structure			
Byte #5 (bits 47 - 40)	Bytes #4 - #2 (bits 39 - 16)	Byte #1 (bits 15 - 8)	Byte #0 (bits 7 - 0)
CONFIGURATION byte	RANGE bytes	FAULTS byte	BIAS VOLTAGE byte

The structure of the **CONFIGURATION** byte (bits 47 – 40) of the status register is hereafter presented:

Bit #	Cell caption
47	<i>do not care</i>
46	External interlock direction (0 – inverse; 1 – direct)
45	External interlock enabled (0 – disabled; 1 – enabled)
44-42	Active channels (1,2 or 4 in binary representation)
41	User correction (0 – disabled; 1 – enabled)
40	ASCII representation (0 – disabled; 1 – enabled)

The structure of the **RANGE** bytes (bits 39 – 16) section of the status register is shown in the following table:

Bit #	Cell caption
39-37	<i>do not care</i>
36	CH4 full scale range (0 – RNG 0; 1 – RNG 1)
35-33	<i>do not care</i>
32	CH3 full scale range (0 – RNG 0; 1 – RNG 1)
31-29	<i>do not care</i>
28	CH2 full scale range (0 – RNG 0; 1 – RNG 1)
27-25	<i>do not care</i>
24	CH1 full scale range (0 – RNG 0; 1 – RNG 1)
23-20	<i>do not care</i>
19	CH4 auto-range (0 – disabled; 1 – enabled)

18	CH3 auto-range (0 – disabled; 1 – enabled)
17	CH2 auto-range (0 – disabled; 1 – enabled)
16	CH1 auto-range (0 – disabled; 1 – enabled)

The structure of the **FAULTS** byte (bits 15 – 8) is as follows:

Bit #	Cell caption
15	General fault (logical or of all faults)
14-11	<i>do not care</i>
10	Bias Over-current fault (latch of a bias overcurrent event)
9	Over-temperature fault (latch of an over-temperature event)
8	External interlock fault (latch of an interlock event)

The last byte of the status register – **BIAS VOLTAGE** byte (bits 7 – 0) are used to signal the status of the Bias Voltage module and its structure is shown hereafter:

Bit #	Cell caption
7-4	<i>do not care</i>
3	Bias over-current (module in over-current condition if '1')
2	Ramp down (when high: HV module is ramping down) <sup>1</sup>
1	Ramp up (when high: HV module is ramping up) <sup>1</sup>
0	Bias voltage module status (0 – OFF; 1 – ON)

A brief description of the binary flags is hereafter presented:

- *External interlock enabled (bit 45)*: this bit is set when the external interlock input is enabled (see INTERLOCK Command section);
- *Active channels (bits 44-42)*: these bits indicate the number of active input channels in binary format (see CHN Command section); so these bits are configured as:
  - o '001', when one channel is activated,
  - o '010', when two channels are activated,
  - o '100', when all four input channels are activated;
- *User correction (bit 41)*: this bit indicates that the user correction function – i.e. user-defined calibration – is enabled (for more information see the USRCORR Command section);

<sup>1</sup> This is valid only for the High-Voltage module.

- *ASCII representation (bit 40)*: this bit is set when the ASCII output stream representation is enabled while it is cleared if the binary representation is activated (see ASCII Command chapter);
- *Full-scale range (bits:36, 32, 28 and 24)*: these bits indicate the ranges on the input channels: the corresponding bit is low when the channel is set to range 0, and it is set when the channel is set to range 1;
- *Auto-range (bits:19, 18, 17 and 16)*: these bits are set when the auto-range option is enabled on the corresponding channel (see RNG Command for more information);
- *General fault (bit 15)*: this bit is set if the module has experienced a fault – e.g. generated by an external interlock or an internal protection trip (like internal over-temperature or Bias Voltage module over-current). This bit is a logical ‘OR’ of all other fault flags and it is latching – i.e. when a fault occurs, this bit is set together with the specific fault bit. When a fault is detected, the module switches off the Bias Voltage module. A status reset of the device is necessary in order to reset the module (see the following section);
- *Bias Over-current fault (bit 10)*: this bit is also latching and it is set when a Bias Voltage over-current event occurs; a status reset is needed in order to reset this bit (see the following section). The maximum output currents for the different high voltage outputs are shown in Bias Voltage Commands;
- *Over-temperature fault (bit 9)*: this bit is also latching and it is set when the internal TetrAMM temperature rises above the 50 °C threshold; to reset this flag it is necessary to execute a status reset command (see following section);
- *External interlock fault (bit 8)*: this bit is set when the external interlock signal is enabled and the input interlock signal is high (see Interlock and general I/O connector section); to reset the flag the it is necessary to execute a status reset (see the following section);
- *Bias over-current (bit 3)*: this bit is set when the Bias Voltage module experience an over-current situation. The maximum output current ratings for the different Bias Voltage models are shown in the Bias Voltage section. This bit is non-latching so that it represents only the actual over-current status of the module. This condition triggers the internal fault over-current bit previously described;
- *Ramp up/Ramp down (bit 2 and bit 1)*: these bits are set when the Bias Voltage is ramping up/down in the process of reaching the selected set-point value. The slew rate of the ramp depends on the Bias Voltage model (see Bias Voltage description). This is valid only for the High-Voltage bias module;
- *Bias voltage module status (bit 0)*: this bit is set only when the Bias Voltage module is enabled and it is cleared in all other cases.

The internal status register can be read with the “STATUS:?\r\n” command. The reply from the TetrAMM unit to this command is in the format “STATUS:value\r\n”, where *value* is the ASCII representation of the internal status register value, composed by 12 hexadecimal digits – corresponding to the 6-byte wide status register (every byte is represented by two hexadecimal digits).

If at least one of the fault conditions occurs, then the respective bit and the general fault bit are set. The Bias Voltage module is switched off in this conditions and it is not possible to enable the module until the internal status register is reset. To command to reset the fault condition of the status register is “STATUS:RESET\r\n”; the TetrAMM unit replies to this command with an acknowledgment string.

**Example:**

STATUS read example:



STATUS reset example:

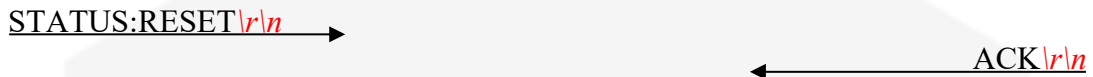

### 2.3.9 PKTSIZE Command

The TetrAMM unit allows to configure the size of the “data” field of the TCP packets. This command is of extreme use when specific network traffic constraints have to be satisfied.

The command to set the “data” field size of the TCP packets is: “PKTSIZE:mode:value\r\n”, where mode can be “D” (default) or “U” (user) and value is an integer that indicates the number of samples to fit in a single TCP packet, with  $1 \leq value \leq 144$ . To set a custom packet size use the command “PKTSIZE:value\r\n”. To set the default packet size value use the command “PKTSIZE:DEFAULT\r\n”. More information about data format and data size can be found in the “ACQ Command” section. The unit replies to this kind of command with an Acknowledge (“ACK\r\n”).

**Example:**

PKTSIZE set example:



PKTSIZE read example:



PKTSIZE set default example:



PKTSIZE:DEFAULT\r\n

← ACK\r\n

PKTSIZE read *example*:

PKTSIZE:?\r\n

← PKTSIZE:D:10\r\n



### 2.3.10 INTERLOCK Command

The TetrAMM unit is provided with an external interlock connector due to detect an external generated signal, which can be used to trigger the external interlock fault and so to switch off the High Voltage module.

The command to enable or disable the external interlock input is the following: “INTERLOCK:mode\r\n”, where *mode* could be “OFF” (*default*) to disable the interlock input or “ON” to enable it. The unit replies to this kind of command with an Acknowledge (“ACK\r\n”).

To read the actual set interlock status it is possible to use the command: “INTERLOCK:?\r\n”. The generated reply to this command has the next form: “INTERLOCK:mode\r\n”, where *mode* could be “OFF” (*default*) if the interlock input is disabled or “ON” if interlock input is enabled.

The interlock direction can be set by using the command “INTERLOCK:DIR:direction\r\n”, where *direction* can be “INV” (*inverse, default*) or “DIR” (*direct*). When “INV” is selected the interlock is active *HIGH*, while when “DIR” is selected the interlock is active *LOW*. The interlock direction can be queried with the command “INTERLOCK:DIR:?”.

The interlock configuration can be saved in the FLASH memory with the command: “INTERLOCK:SAVE”. When this command is executed the actual interlock mode and interlock direction are saved into the FLASH and loaded at start-up. In this way the default interlock mode and interlock direction can be overridden.

#### Example:

INTERLOCK set example:

```
INTERLOCK:ON\r\n →                                     ← ACK\r\n
```

INTERLOCK read example:

```
INTERLOCK:?\r\n →                                     ← INTERLOCK:ON\r\n
```

INTERLOCK:DIR set example:

```
INTERLOCK:DIR:DIR\r\n →                               ← ACK\r\n
```

INTERLOCK default parameter override

```
INTERLOCK:SAVE\r\n →                                   ← ACK\r\n
```

### 2.3.11 TEMP Command

TEMP Command (“TEMP:?*r*\n”) allows user to read temperature from internal temperature sensor. Temperature value is updated every 10 seconds. If in case temperature rises over 50°C, the over-temperature fault is set and the High Voltage module is turned off. After a fault event it is necessary to reset the internal status register, to be able to reactivate the Bias Voltage module.

The reply to the TEMP command is in the following format: “TEMP:*value*\n”, where *value* is the integer read temperature value expressed in °C.

#### Example:

TEMP read example:

TEMP\n (or) TEMP:?\n

TEMP:28\n

### 2.3.12 VER Command

The “VER\n” command returns information about the TetrAMM unit and the currently installed firmware version.

The reply to the “VER\n” command is in following format:

VER:*model*:*ver*:*module1*:*module2*\n

where:

- *model*: is a string indicating the device (i.e. “TETRAMM”);
- *ver*: contains the string corresponding to the installed firmware version;
- *module1*: the front-end type installed in the device and the two full-scale ranges;
- *module2*: the Bias Voltage module installed in the device and its voltage rating.

#### Example:

VER example:

VER\n

VER:TETRAMM:0.9.81:IV4 120UA 120nA:HV 500V POS\n

The “TETRAMM” device of the previous example has the “0.9.81” firmware version installed and it has a 4-channel “current-to-voltage” front-end (i.e. “IV4”) with the two full-scale ranges rated at 120µA and 120nA. The Bias Voltage module installed has a 500V output voltage rating.

### 2.3.13 HWRESET Command

The “HWRESET\r\n” command performs a complete reset of the hardware and firmware on the on-board FPGA, thus re-initializing the entire TetrAMM module control electronics. The unit replies with an acknowledgment string (“ACK\r\n”) before resetting the module.

#### Example:

HWRESET example:

HWRESET\r\n → ← ACK\r\n

### 2.3.14 TRGPOL Command

The TRGPOL command is used to set the triggering on the high level or low level of the “Trigger” signal.

The reply to a TRGPOL:? command is the current polarity set:

TRGPOL:?\r\n → ← TRGPOL:POS\r\n

TRGPOL:POS (default configuration) command is used to set the triggering on the high level of the “Trigger” signal:

TRGPOL:POS\r\n → ← ACK\r\n

TRGPOL:NEG command is used to set the triggering on the low level of the “Trigger” signal:

TRGPOL:NEG\r\n → ← ACK\r\n

### 2.3.15 NTRG Command

The NTRG command is used to set the number of consecutive trigger events before stopping the acquisition. Accepted values are in the range [0, 1e6]. Continuous triggering is obtained by setting NTRG to 0 (this is equivalent to the “continuous” trigger acquisition function of most oscilloscopes). Single triggered acquisition is obtained by setting NTRG to 1 (*default* configuration). Multiple triggered acquisitions are obtained by setting NTRG > 1.

The reply to a NTRG:? command is the current number of consecutive trigger events value:

NTRG:? \r\n → NTRG:1 \r\n ←

Set NTRG to a new value with the following command:

NTRG:0 \r\n → ACK \r\n ←

### 2.3.16 SEQNR Command

The SEQNR command is used to set the sequence number of acquisition in “trigger mode”. Accepted values are positive values.

The reply to a SEQNR:? command is the current number of consecutive trigger events value:

SEQNR:? \r\n → SEQNR:0 \r\n ←

Set SEQNR to a new value with the following command:

SEQNR:1 \r\n → ACK \r\n ←

### 2.3.17 TRGOUT and THR Commands

The TRGOUT command is used to set the output trigger configuration. The diagram below shows the trigger logic exemplified for one channel. The blue rectangles in the diagram correspond to all the available output trigger configuration commands which are described in the following subsections.

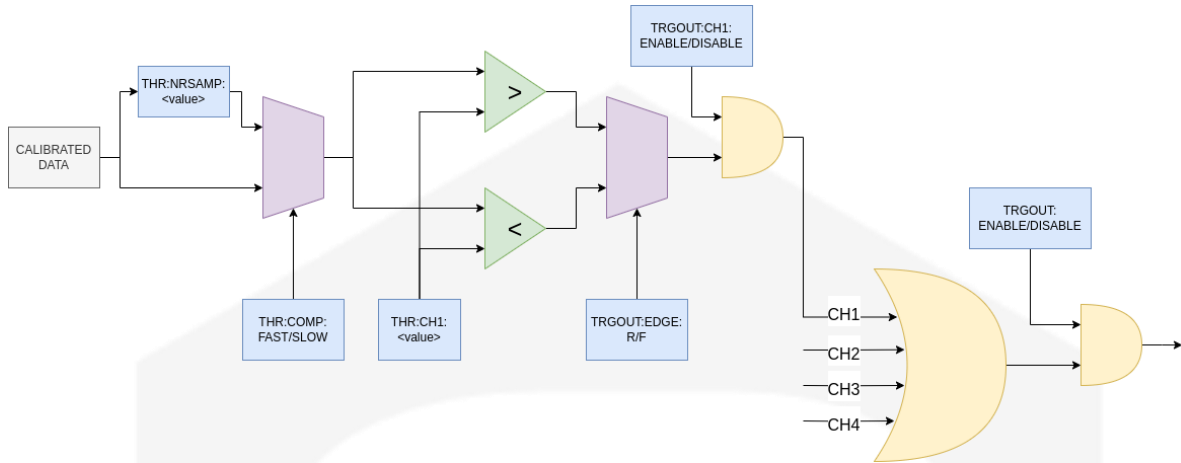

#### 2.3.17.1 TRGOUT Enable Command

The “TRGOUT:ENABLE\r\n” command let the user enable the trigger out feature. To disable the trigger out feature use the command “TRGOUT:DISABLE\r\n”. To check if the trigger out feature is enabled or not use the query command “TRGOUT:?\r\n”.



Once the trigger out feature is enabled, it is possible to select which channel to enable or disable with the command “TRGOUT:CHx:<option>\r\n”, where “x” is the channel number (from 1 to 4) and “<option>” can be “ENABLE” or “DISABLE”. To check if a channel is enabled or disabled use the query command “TRGOUT:CHx:?\r\n”.

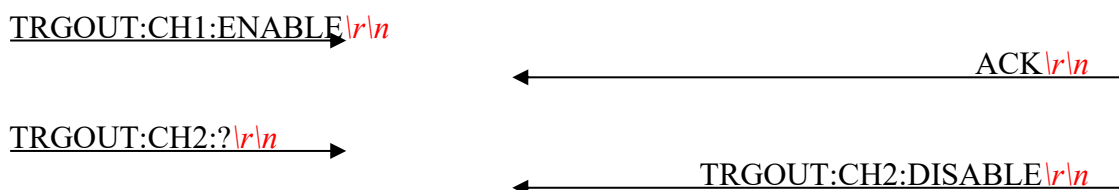

### 2.3.17.2 THR Threshold Command

The trigger threshold command allows the user to set a threshold independently for each channel. To set the threshold use the command “THR:CHx:<value>|r|n”, where “x” is the channel number (from 1 to 4) and “<value>” is a float number in [A] representing the threshold.

```
THR:CH1:1e-12|r|n →
← ACK|r|n
```

To query the trigger threshold value use the query command “THR:CHX:?:r|n”.

```
THR:CH1:?:r|n →
← THR:CH1:1e-12|r|n
```

### 2.3.17.3 THR Threshold Comparison Command

The trigger out comparison feature allows the user to select between two options. The first, called FAST, compares the threshold with the 100 kHz sampled data. The second option, called SLOW, compares the thresholds with an average of the 100 kHz sampled data. The default average is set to 8 samples, which means 12.5 kHz data.

To set the threshold comparison option use the command “THR:COMP:<option>|r|n”, where “<option>” can be “FAST” or “SLOW”.

```
THR:COMP:FAST|r|n →
← ACK|r|n
```

To query the trigger threshold comparison configuration use the query command “THR:COMP:?:r|n”.

```
THR:COMP:?:r|n →
← THR:COMP:FAST|r|n
```

### 2.3.17.4 THR Set Average Samples

In THR:COMP:SLOW the threshold are compared with an averaged version of the sampled data coming from the ADC. The default average is made on 8 samples (simple average computation) but it is also possible to set a different number of samples by using the command “THR:NRSAMP:<value>|r|n”, where “<value>” is an integer number between 2 and 1000.

THR:NRSAMP:100|r|n → ACK|r|n ←

To query the NRSAMP value use the query command “THR:NRSAMP:?|r|n”.

THR:NRSAMP:?|r|n → THR:NRSAMP:100|r|n ←

### 2.3.17.5 TRGOUT Edge Command

The trigger edge command allows the user to set the edge direction that triggers the trigger out signal. To set the trigger edge use the command “TRGOUT:EDGE:<option>|r|n”, where “<option>” can be “R” for rising edge or “F” for falling edge.

TRGOUT:EDGE:R|r|n → ACK|r|n ←

To query the trigger edge configuration use the query command “TRGOUT:EDGE:?|r|n”.

TRGOUT:EDGE:?|r|n → TRGOUT:EDGE:R|r|n ←

### 2.3.17.6 TRGOUT Mode Command

The trigger mode command allows the user to set the trigger out mode configuration from single to continuous. To set the trigger mode use the command “TRGOUT:MODE:<option>\r\n”, where “<option>” can be “SINGLE” for single trigger acquisition or “AUTO” for trigger continuous acquisition.

TRGOUT:MODE:AUTO\r\n → ← ACK\r\n

To query the trigger edge configuration use the query command “TRGOUT:MODE:?\r\n”.

TRGOUT:MODE:?\r\n → ← TRGOUT:MODE:AUTO\r\n

### 2.3.17.7 TRGOUT Status Command

The trigger status command allows the user to check which channel has currently generated a trigger out condition. The status register is represented as 4 bits, the MSB corresponds to CH4 and the LSB corresponds to CH1. To check the status register, use the command “TRGOUT:STATUS:?\r\n”.

TRGOUT:STATUS:?\r\n → ← 0101\r\n

Response “0101” means that CH3 and CH1 have generated a trigger, while CH4 and CH2 did not. To clear the status register and rearm the trigger (if in “SINGLE” mode) the clear status register command can be used: “TRGOUT:STATUS:CLEAR\r\n”.

TRGOUT:STATUS:CLEAR\r\n → ← ACK\r\n

## 2.4 DEVID Command

The “DEVID:?\r\n” command returns four characters that are saved into EEPROM that can be used to identify the device. The user can change this Device ID by using the command “DEVID:SAVE:<value>\r\n”, where value is a string of four characters. The unit replies with an acknowledgment string (“ACK\r\n”) if the “<value>” string is exactly four characters, otherwise it responds with a “NAK:<error\_code>\r\n” and its corresponding error code. Default Device ID is “CELS”.

### Example:

DEVID example:

DEVID:?\r\n → ← CELS\r\n

## 2.5 Bias Voltage Commands

The commands that can be used to set and to read the settings of the Bias Voltage module installed in the TetrAMM are described in this section.

### 2.5.1 HVS Command

The HVS command lets user to set and read the Bias Voltage output status/value. In order to set a voltage value, i.e. send the command “HVS:ON\r\n”, it is necessary to enable the Bias Voltage module first. When the Bias Voltage module is turned on then the red led “ON” on the front panel of the TetrAMM unit turns on too. The command “HVS:OFF\r\n” disables the Bias Voltage output, putting it into an high impedance state in the HV version and shortening the output to ground in the LV version, and turns off the “ON” led on the front panel.

When the module is enabled, it is possible to set an output voltage value by sending a “HVS:value\r\n”, where *value* is the desired voltage output expressed in [V] (for example to set an output voltage of 100.5 V the following command has to be sent to the unit: “HVS:100.5\r\n”). The output voltage reaches the set-point on a ramping behaviour. The full-scale value and polarity of the Bias Voltage module depend on the HV module option. This command also allows to check the last sent set-point value by sending the “HVS:?\r\n” string. The response to this read command is in the format “HVS:value\r\n”, where *value* is the last given set-point value expressed in [V] with 2-digit decimal precision.

**Examples:**

HVS ON example:

HVS:ON\r\n → ← ACK\r\n

HVS OFF example:

HVS:OFF\r\n → ← ACK\r\n

HVS set example (for a Bias Voltage model with positive polarity):

HVS:490.7\r\n → ← ACK\r\n

HVS set example (for a Bias Voltage model with negative polarity):

HVS:-400.5\r\n → ← ACK\r\n

HVS read example:

HVS:?\r\n → ← HVS:-400.50\r\n

If the set voltage is higher than the maximum voltage allowed by the bias channel mounted on the device, a NAK reply is given:

HV set example (for a Bias Voltage model with 500V maximum):

HV:505\r\n → ← NAK\r\n

**2.5.1.1 Low-Voltage bias module: additional commands**

When the TetrAMM is equipped with the Low-Voltage bias module, the user can set a maximum ( $V_{\max}$ ) and a minimum ( $V_{\min}$ ) voltage limit. When this limit is exceeded a NAK reply is returned. The  $V_{\max}$  and  $V_{\min}$  values are set by default to +30 V and -30 V, respectively. These values can be changed by the user with the commands “HVS:VMAX:value\r\n” and “HVS:VMIN:value\r\n”, respectively. These values are saved temporarily and will be cancelled with a power-cycle of the TetrAMM. To check the actual  $V_{\max}$  and  $V_{\min}$  values the user can perform a query: “HVS:VMAX:?\r\n” or “HVS:VMIN:?\r\n”.

HVS VMAX set example:

HVS:VMAX:5.5\r\n → ← ACK\r\n

HVS set example:

HVS:5.6\r\n → ← NAK:54\r\n

HVS:VMAX query example:

HVS:VMAX:?\r\n → ← 5.5\r\n

Additionally, the user can set a maximum ( $I_{\max}$ ) and a minimum ( $I_{\min}$ ) current limit. When one of these limits is exceeded the Low-Voltage module goes in over-current state (OVC “fault” state) and the output of the Low-Voltage bias module is automatically disabled. The  $I_{\max}$  and  $I_{\min}$  values are set by default to +15 mA and -15 mA, respectively. These values can be changed by the user with the commands “HVS:IMAX:value\r\n” and “HVS:IMIN:value\r\n”, respectively. These values are saved temporarily and will be cancelled with a power-cycle of the TetrAMM. To check the actual  $I_{\max}$  and  $I_{\min}$  values use the query commands: “HVS:IMAX:?\r\n” or “HVS:IMIN:?\r\n”.

HVS IMAX set example:

HVS:IMAX:1e-3\r\n → ← ACK\r\n

HVS IMAX set example (IMAX must be positive and IMIN must be negative):

HVS:IMAX:-1e-3\r\n → ← NAK:\r\n

HVS:IMAX query example:

HVS:IMAX:?\r\n → ← 1e-3\r\n

## 2.5.2 HVV Command

The HVV command allows user to read the output voltage of the Bias Voltage module by sending the “HVV:?  
r\n” command. The reply to this command is in the following format “HVV:value  
r\n”, where *value* is the output voltage readback value expressed in [V] with a 2-digit decimal precision – i.e. with a 10-mV resolution.

### Example:

HVV example:

HVV:?  
r\n

HVV:400.69  
r\n

## 2.5.3 HVI Command

The HVI command allows reading the current provided by the Bias Voltage module. The command to read the current value is “HVI:?  
r\n”. The reply to this command is in the following format “HVI:value  
r\n”, where *value* is the read output current expressed in microamperes [ $\mu$ A] with 2-digit decimal precision – i.e. with a 10-nA resolution.

### Example:

HVI example:

HVI:?  
r\n

HVI:0.54  
r\n

## 2.6 Command Table Summary

Command	Purpose	Parameters
ACQ	Start continuous acquisition	:ON
	Stop continuous acquisition	:OFF
ASCII	Enable ASCII output stream	:ON
	Disable ASCII output stream	:OFF
	Query ASCII setup setting	:?
CHN	Set number of reading channels	:[1 - 4]
	Query channel settings	:?
FASTNAQ	Read a fixed number of samples without averaging on 4 channels	:[1 - 419.430]
	Read a fixed number of samples without averaging on 2 channels	:[1 - 699.050]
	Read a fixed number of samples without averaging on 1 channel	:[1 - 1.048.576]
G, GET	Get single reading	:? /
?, HELP	Displays the commands list	/
HVI	Read the output current provided by the Bias Voltage module	:?
HVS	Enable Bias voltage module	:ON
	Disable Bias voltage module	:OFF
	Set the desired Bias Voltage set point	:[0 – $HV_{full\ range}$ ]
	Set bias voltage limits (only for Low-Voltage bias module)	:VMAX:value :VMIN:value
	Query bias voltage limits (only for Low-Voltage bias module)	:VMAX:? :VMIN:?
	Query Bias Voltage set point	:?
HVV	Read the output voltage provided by the Bias Voltage module	:?
HWRESET	Perform a hardware and firmware reset	/
IFCONFIG	Print the network configuration of the device	/
INTERLOCK	Enable external interlock input	:ON
	Disable external interlock input	:OFF
	Query interlock setting	:?
	Select interlock direction (DIR for “direct”, INV for “inverse”). “?” for query interlock direction.	:DIR:DIR :DIR:INV :DIR:?
	Save interlock settings to FLASH (loaded at start-up)	:SAVE
NAQ	Read a fixed number of samples	:[1 - 2.000.000.000]

<b>NRSAMP</b>	Set number of samples on which averaging is made	: [5 – 100.000]
	Query number of averaged samples settings	: ?
<b>PKTSIZE</b>	Set TCP tx packet size	: [1 – 144]
	Query TCP tx packet size	: ?
	Set TCP tx packet size to default	: DEFAULT
<b>RNG</b>	Set full scale range to the maximum on all input channels	: 0
	Set full scale range to the minimum on all input channels	: 1
	Set full-automatic range selection to all input channels	: AUTO
	Query range setup status	: ?
<b>STATUS</b>	Query device status	: ?
	Reset status fault conditions	: RESET
<b>TEMP</b>	Read the devices internal temperature	/ : ?
<b>TRG</b>	Enable trigger mode	: ON
	Disable trigger mode	: OFF
<b>NTRG</b>	Set the number of consecutive triggered acquisitions	: [0, 1e6]
	Query number of consecutive triggered acquisitions	: ?
<b>TRGOUT</b>	Enable Trigger Out Feature	: ENABLE
	Disable Trigger Out Feature	: DISABLE
	Query Trigger Out Enable	: ?
	Enable Single Channel Trigger Out Feature	: CHx: ENABLE
	Disable Single Channel Trigger Out Feature	: CHx: DISABLE
	Query Single Channel Enable Feature	: CHx: ?
	Set Trigger Out Edge Rising	: EDGE: R
	Set Trigger Out Edge Falling	: EDGE: F
	Query Trigger Out Edge Configuration	: EDGE: ?
	Set Trigger Out Mode Configuration to Single	: MODE: SINGLE
	Set Trigger Out Mode Configuration to Auto (Continuous)	: MODE: AUTO
	Query Trigger Out Mode Configuration	: MODE: ?
	Check Trigger Out Status Register	: STATUS: ?
	Clear Trigger Out Status Register	: STATUS: CLEAR
	<b>THR</b>	Set Channel Trigger Out Threshold
Query Channel Trigger Out Threshold		: CHx: ?
Set Trigger Out Threshold Comparison Config to Fast		: COMP: FAST
Set Trigger Out Threshold Comparison Config to Slow		: COMP: SLOW
Query Trigger Out Threshold Comparison Config		: COMP: ?

	Set number of samples for average in MODE:SLOW	:NRSAMP:<int>
	Query the number of samples for average in MODE:SLOW	:NRSAMP:?
<b>TRGPOL</b>	Set negative trigger polarity	:NEG
	Set positive trigger polarity	:POS
	Query trigger polarity	:?
<b>USRCORR</b>	Enable user-correction	:ON
	Disable user-correction	:OFF
	Query user-correction status	:?
	Set gain correction on range#y ch#x to value	RNGxCHyGAIN:value
	Query gain correction value on range#x ch#y	:RNGxCHyGAIN :?
	Set offset correction on range#x ch#y to value	RNGxCHyOFFS:value
	Query offset correction value on range#x ch#y	:RNGxCHyOFFS:?
<b>DEVID</b>	Query device ID	:?
	Change device ID	:SAVE
<b>VER</b>	Query the device model and version	/
<b>SEQNR</b>	Sets Sequence number for trigger	:value
	Query sequence number of trigger	:?

## 3. Ethernet Communication

The communication with the TetrAMM unit is based on a 10/100/1000 Mbps Ethernet link. The suggested connection speeds are 100 Mbps or 1 Gbps since the 10 Mbps connection is limiting the data rate.

The factory network configuration and the “*ELS Device Manager*” software are described in the following sections.

### 3.1 IP Address Assignment

The device is shipped with default IP address, subnet mask, gateway and TCP-IP communication port:

Parameter	Factory value
<i>IP address</i>	<b>192.168.0.10</b>
<i>Subnet mask</i>	<b>255.255.255.0</b>
<i>Gateway</i>	<b>192.168.0.1</b>
<i>TCP/IP port</i>	<b>10001</b>

Even if the TetrAMM device can be connected to a LAN network, a point-to-point Ethernet connection is strongly recommended in order to obtain minimum delay, maximum data rate performance and to avoid possible communication problems – i.e. increasing communication reliability. This implies that the host PC and the TetrAMM should reside on the same Ethernet subnet.



For a point-to-point connection it is not necessary to use a twisted cable because the used Ethernet link has an automatic detection of the communication direction – i.e. auto-sensing.

To change the device network setup, it is necessary to use the free “*ELS Device Manager*” software that can be downloaded from the ELS Instruments website [els-instruments.com](http://els-instruments.com). A briefly description of this software is given in next section.

## 3.2 ELS Device manager

The free software “*ELS Device manager*” can be used to search for all the TetrAMM devices connected to the local network and to configure them. This software also allows to set the network configuration of the found devices and to update their firmware.

The “*ELS Device manager*” is available for Windows and Linux platform and the system requirements hereafter listed:

-  Windows minimum system requirements:
  - Windows® XP or newer
  - Intel® or equivalent processor
  - 70 MB available HD space
  - Ethernet network card
-  Linux minimum system requirements:
  - Linux kernel 2.2.x or newer
  - Intel® or equivalent processor
  - 70 MB available HD space
  - Ethernet network card

### 3.2.1 Searching for connected devices

Please follow the next steps in order to search for the TetrAMM devices connected to the local network:

- connect the host PC and the TetrAMM directly with an Ethernet cable (or through a network);
- verify that the “*Link LED*” on the RJ45 connector is turned on (**amber** for a 1 Gbps connection as shown in **Figure 4** or **green** for a 100 Mbps connection). The LED is turned off if the Ethernet cable is not connected or if the speed of connection is limited to 10 Mbps (in this last case the device is working correctly even if it is not recommended to use a slow connection since the data transfer rate is limited);

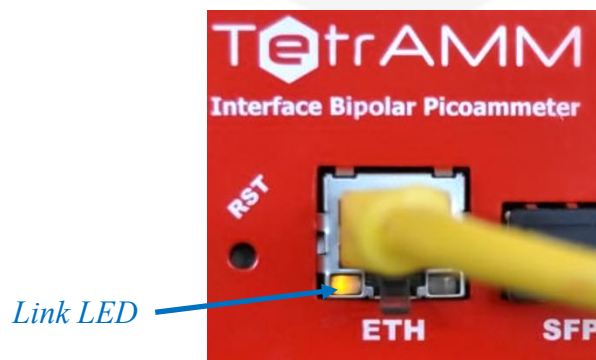

**Figure 4:** Ethernet Link

- connect the TetrAMM to the AC/DC power supply unit and switch it on;
- install and launch the “*ELS Device manager*” software;
- perform a scan to discover the connected TetrAMM devices by clicking the “*Scan*” button as indicated in **Figure 5**. If there are multiple available networks it is possible to select the network/networks to be scanned in the “*Selected network interfaces*” window available under the “*Options*” menu. All the information about the selected devices is shown in the right side of the main window.

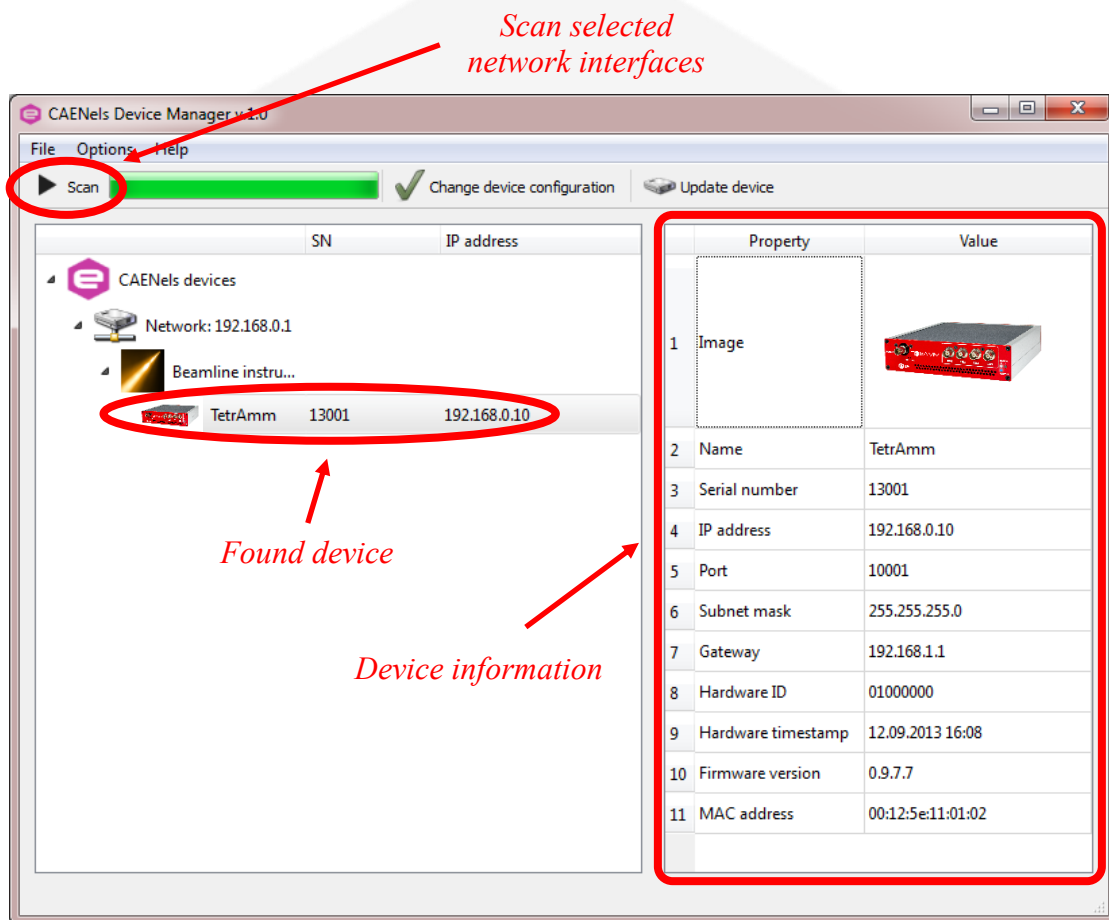

**Figure 5:** Main interface

If you have a firewall enabled on your router or on your computer, please make sure that the firewall is not preventing communication between your computer and the TetrAMM device.

The “*ELS Device manager*” uses **UDP port 30719** to find the device, so make sure that the UDP traffic is allowed in both directions on that port.

### 3.2.2 Device Configuration

It is possible to change the Network configuration of the found devices. In order to set the Network configuration, it is necessary to select the desired device and to click on the “*Change device configuration*” button in the main window as shown in **Figure 6**. The configurable Network options are:

- Device IP address;
- TCP/IP communication port;
- Subnet mask;
- Gateway.

To apply the changes on the device configuration it is necessary to edit the corresponding fields and then to click on the “*Save*” button. A screenshot of a sample device configuration is shown in the following picture:

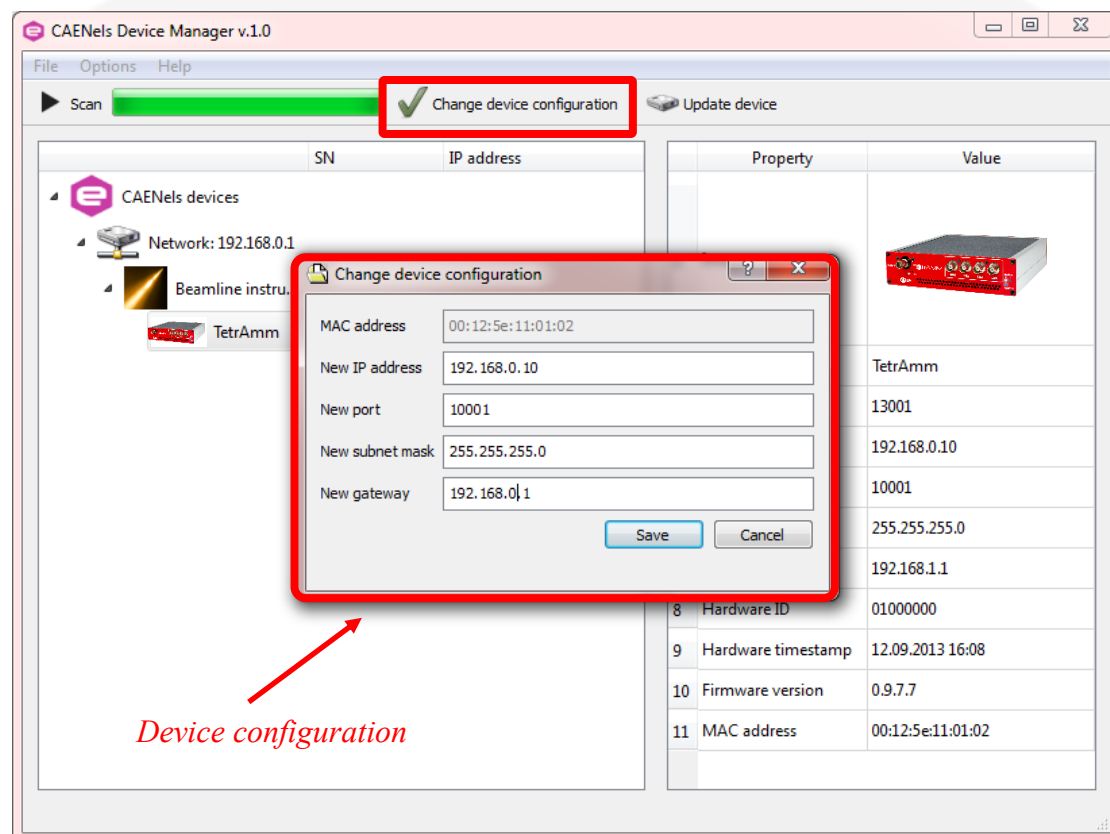

**Figure 6:** Change device configuration

### 3.2.3 Firmware Upgrade

The “*ELS Device manager*” software also allows remotely updating the firmware of the TetrAMM devices. Once the desired device is found, it is possible to perform the firmware update by clicking on the “*Update device*” button as shown **Figure 7**. The new opened window allows to select the new firmware file (*Flash file - \*.flash*). **Disconnect all the TetrAMM input channels during the update procedure.**

Once the flash file has been selected it is possible to start the firmware update by clicking the “*Update!*” button. The firmware update task will take a few minutes. A screenshot of the update menu is shown hereafter:

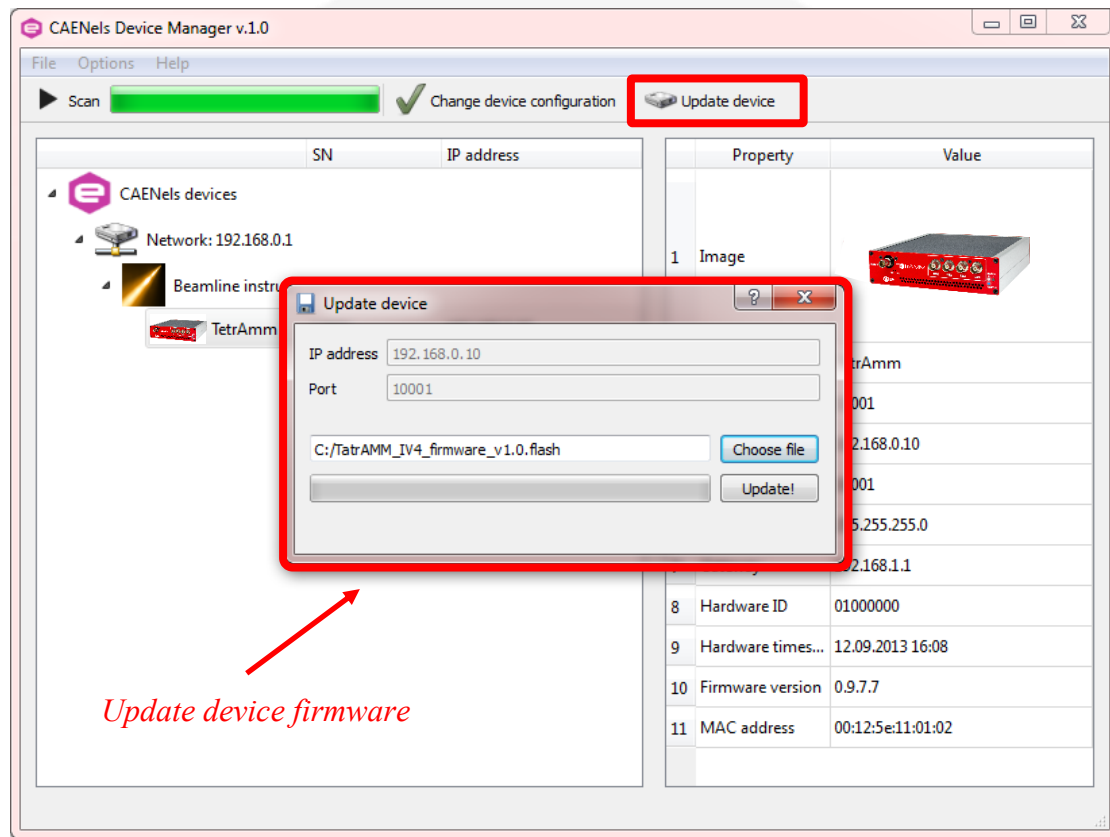

Figure 7: Update device

## 4. I/O Connectors

This chapter describes the I/O connectors present on the device front and rear panels, their corresponding pinout and each signal functionality.

### 4.1 Power Connector

The input power connector is a standard male locking jack socket. The input voltage is rated at +12 V ( $\pm 3\%$ ) with a maximum input current of 1 A.

The input ON/OFF switch is placed above the input power connector which allows turning ON or OFF the device. The used connector is shown in **Figure 8**:

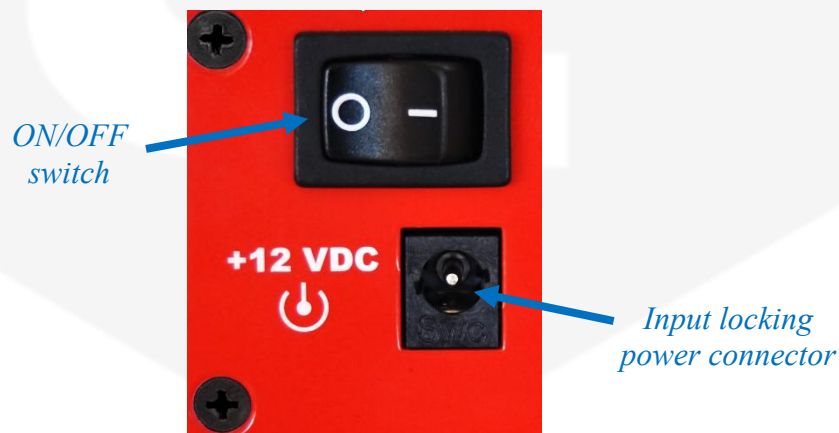

**Figure 8:** Power connector and switch

## 4.2 Triggers Connector

The TetrAMM device has two input and one output trigger signals on LEMO coaxial connectors. These input/output connectors are called “*Triggers*” and are placed on the rear panel of the device as shown in **Figure 9**:

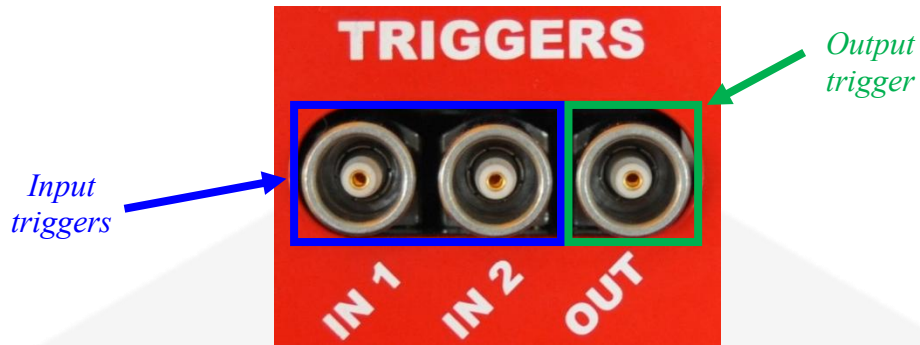

**Figure 9:** “*Triggers*” connectors on rear panel

Signal levels are TTL, LVTTTL and CMOS compatible. The maximum rated output current is 24mA.

The “*IN 1*” input is also called “*Trigger/Gate*” signal and it is used to synchronize the acquisition of the device to an external event (for more information please refer to TRG Command section).

The “*IN 2*” connector is reserved for future uses.

The “*OUT*” output is used for the “*Trigger Out*” capability.

The recommended mating LEMO connector part number is FFA.00.250.NTAC29.



**Figure 10:** FFA.00.250.NTAC29 mating connector

### 4.3 Interlock and general I/O connector

The “Interlocks and general I/O” connector, that has the pinout configuration described in **Figure 10**, is present on the rear panel of the TetrAMM unit:

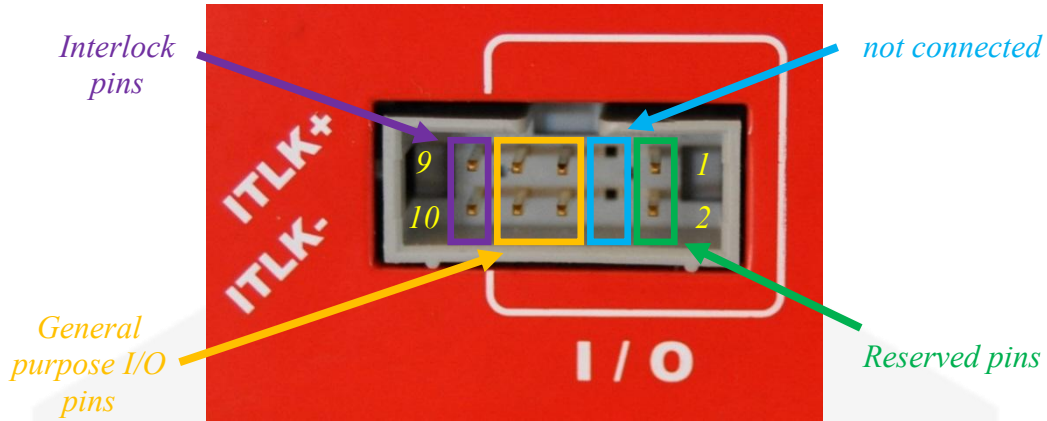

**Figure 11:** Interlock and I/O connector

The pin functions are summarized in the next table:

Pin #	Function
1-2	Reserved pins
3-4	<i>not connected</i>
5-8	General purpose I/O pins
9-10	External interlock pins

The “*External interlock pins*” (pins 9-10) can be used to detect an external signal that can be used to trigger the external interlock fault and to switch off the High Voltage module (see INTERLOCK Command and STATUS Command Commands sections for more information). The interlock pins are galvanically isolated from ground.

Positive voltage must be applied to “ITLK+” and negative voltage to “ITLK-“, the maximum voltage that can be applied to the interlock “ITLK+” terminal is rated at **+24V** (the minimum signal that guarantees the tripping of this interlock is rated at +3V); the maximum reverse voltage that this interlock can sustain is rated at -5.5V.

An equivalent circuit is presented below in **Figure 12**:

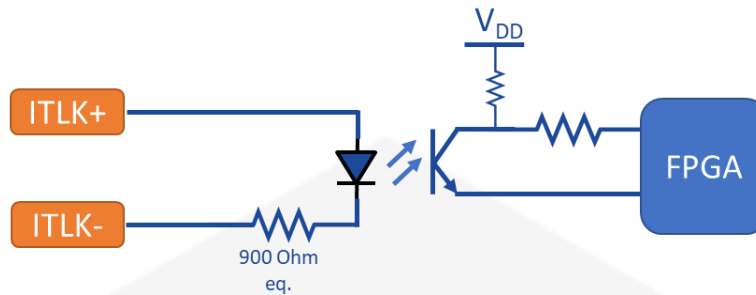

**Figure 12:** Interlock equivalent circuit

The “*General purpose I/O pins*” (pins 5-8) are connected to the internal digital section and they are reserved for future system updates.

The “*not connected pins*” (pins 3-4) are not present or if present, they are not connected to the internal digital system.

The “*Reserved pins*” (pins 1-2) are connected to the internal digital section and are reserved for internal use, so they must NOT be connected.

## 4.4 Ethernet and SFP connector

On the rear side of the TetrAMM unit there are also a RJ45 Ethernet connector and a small form-factor pluggable (SFP) slot as indicated in **Figure 13**:

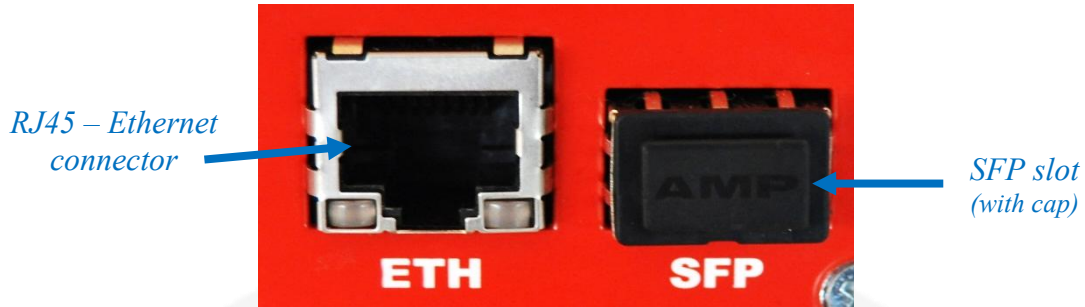

**Figure 13:** Ethernet and SFP connections

The RJ45 Ethernet slot is used to communicate with TetrAMM unit. The connector is linked to a true 10/100/1000 Mbps physical device. For more information about the Ethernet communication see the Ethernet Communication section.

The SFP slot allows connecting a copper or optic platform to the internal digital system with a fixed speed of 1 Gbps and it is reserved for future system updates – e.g. beamline local feedback system.

## 4.5 Input BNC connectors

The four BNC connectors (Bayonet Neill-Concelman) on the front panel of the TetrAMM unit are used to measure the input currents. The BNC connectors are miniature quick connect/disconnect RF connectors mainly used for coaxial cables.

Channel incremental numbering, as can be seen in **Figure 14**, is right-to-left (CH1 is the one the right while CH4 is the one on the left):



**Figure 14:** BNC input connectors

**The TetrAMM unit has to be placed next to the current source (e.g. detector) in order to reduce cable lengths – i.e. cable capacitance – and to minimize consequent noise pick-up.**

## 4.6 Output Bias Voltage Connector

The Bias Voltage output connector depends on the type of bias voltage source installed on the specific TetrAMM device. Two different connectors are available as follows.

### 4.6.1 Low-Voltage Bias Connector (BNC)

A BNC connector is present on the front panel (refer to **Figure 15**) of the device and provides a bias voltage bias source for the detecting system connected to the TetrAMM. This connector is present in the bias voltage versions up to  $\pm 30$  V.



**Figure 15:** Bias Voltage BNC connector

The ON light indicates that the high-voltage source is present on the SHV connector while the OVC light is ON if the module is experiencing an over-current condition. **When turned OFF, the BIAS OUT is directly shortened to ground by an internal switch in this version** (see Figure 16).

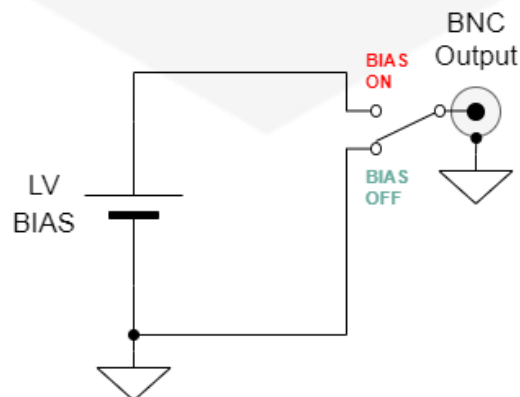

**Figure 16:** LV Bias Output Connections

## 4.6.2 High-Voltage Bias Connector (SHV)

A SHV connector is present on the front panel (refer to **Figure 17**) of the device and provides a high voltage bias source for the detecting system connected to the TetrAMM. The connector is similar to the BNC but uses a very thick and protruding insulator.



**Figure 17:** High Voltage SHV connector

The insulation geometry makes SHV connector safe for handling high voltage sources, by preventing accidental contact with the live conductor in an unmated connector or plug. **When turned OFF, the BIAS OUT goes into high-impedance state in the version.**

## 5. Technical Specifications

Main technical specifications for the TetrAMM unit are shown in the following table (values for the **WTETRAMM05PX** model are shown):

Specifications	Value
Input Channels	4
Current Measuring Ranges	RANGE 0: up to $\pm 120 \mu\text{A}$ RANGE 1: up to $\pm 120 \text{nA}$
Current Resolution	RANGE 0: 15 pA RANGE 1: 15 fA
Current Polarity	Bipolar
Sampling Frequency	100 kHz
Sampling bits	24
Analog bandwidth – BW	5 kHz
Equivalent Input Current Noise (@1 ksps) - max	Range 0: 1.5 ppm/FS Range 1: 6 ppm/FS
Equivalent Input Current Noise (@100 ksps) - max	Range 0: 5 ppm/FS Range 1: 25 ppm/FS
Temperature Coefficient - TC	Range 0: $< 0.001 \text{ \%}/\text{FS}/^\circ\text{C}$ Range 1: $< 0.0012 \text{ \%}/\text{FS}/^\circ\text{C}$
Data rate	Up to 100 ksamples/s/ch
Communication	Ethernet 10/100/1000 TCP-IP
Extra Communication Interface	SFP – Small form-factor pluggable
External Signals	Configurable Trigger/Gate Trigger Output External Interlock
Fault conditions	External interlock Internal over-temperature Bias Voltage Over-Current
Bias Voltage Source	500 V @ 1 mA (standard)

Nigh Voltage Noise + Ripple – typ.	< 1 mV <sub>RMS</sub> < 3 mV <sub>PK-PK</sub>
Input connectors	BNC
Output High Voltage connector	SHV
Additional Features	Firmware remote update Sampling Avaraging High Voltage readout High Voltage current readout Ecternal interlock protections High Voltage Over-Current protection
Input Voltage Supply	+12 V
Cooling Method	Blower Fan
Dimensions	195 x 173 x 45 mm
Weight	850 g

Custom models differ in terms of the current measuring ranges as shown in section 1.8.

## 5.1 Equivalent Input Noise

The equivalent input noise of the TetrAMM depends both on the data rate (and thus the equivalent bandwidth) and the selected measuring range. A table and a plot with typical values for the equivalent input noise vs. the sampling period for the RANGE 0 (full-scale current of  $\pm 120 \mu\text{A}$ ) is shown hereafter for the **WTETRAMM05PX** model.

### RANGE 0 – Full-Scale $\pm 120 \mu\text{A}$ (Model WTETRAMM05PX)

Sampling Period	Data Rate	Equivalent Input Noise (ppm/FS)
10 $\mu\text{s}$	100 kHz	5.8
50 $\mu\text{s}$	20 kHz	2.8
100 $\mu\text{s}$	10 kHz	2.2
200 $\mu\text{s}$	5 kHz	1.7
500 $\mu\text{s}$	2 kHz	1.3
1 ms	1 kHz	1.1
2 ms	500 Hz	1.0

10 ms

100 Hz

0.7

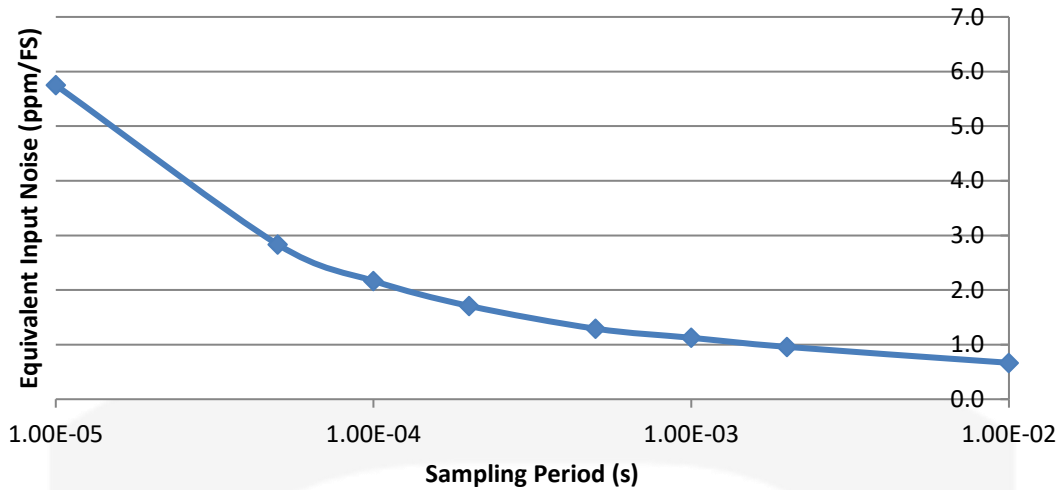
**Equivalent Input Noise (RANGE 0)**

The same values for the RANGE 1 (full-scale current of  $\pm 120$  nA) are presented in the following table and plot.

**RANGE 1 – Full-Scale  $\pm 120$  nA (Model [WTETRAMM05PX](#))**

Sampling Period	Data Rate	Equivalent Input Noise (ppm/FS)
10 $\mu$ s	100 kHz	24.2
50 $\mu$ s	20 kHz	19.6
100 $\mu$ s	10 kHz	16.7
200 $\mu$ s	5 kHz	12.9
500 $\mu$ s	2 kHz	8.3
1 ms	1 kHz	5.8
2 ms	500 Hz	4.2
10 ms	100 Hz	1.8

### Equivalent Input Noise (RANGE 1)

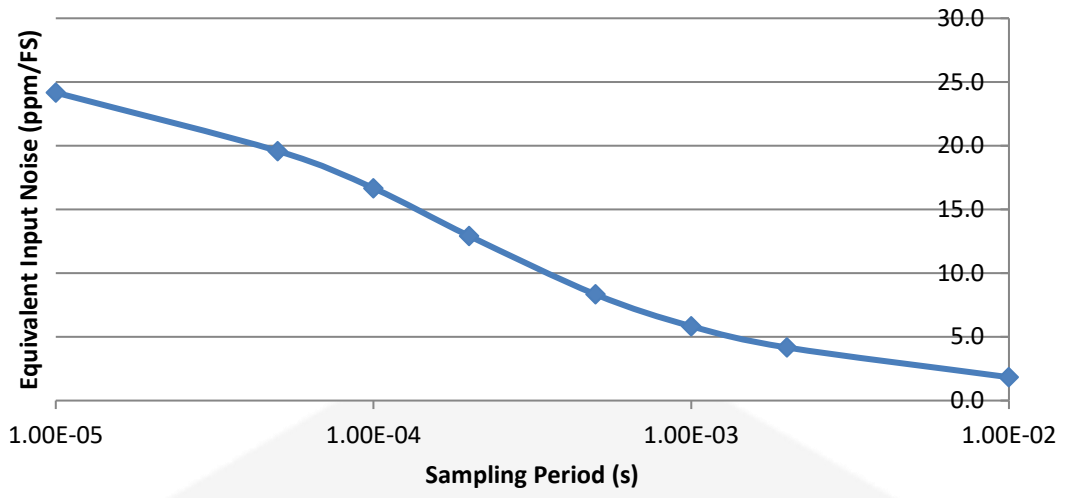

## 6. Mechanical Dimensions

The maximum mechanical dimensions of the TetrAMM unit, including connectors, are hereafter presented in **Figure 14** (the version with the bias SHV connector is shown, the BNC connector is just 1 mm shorter):

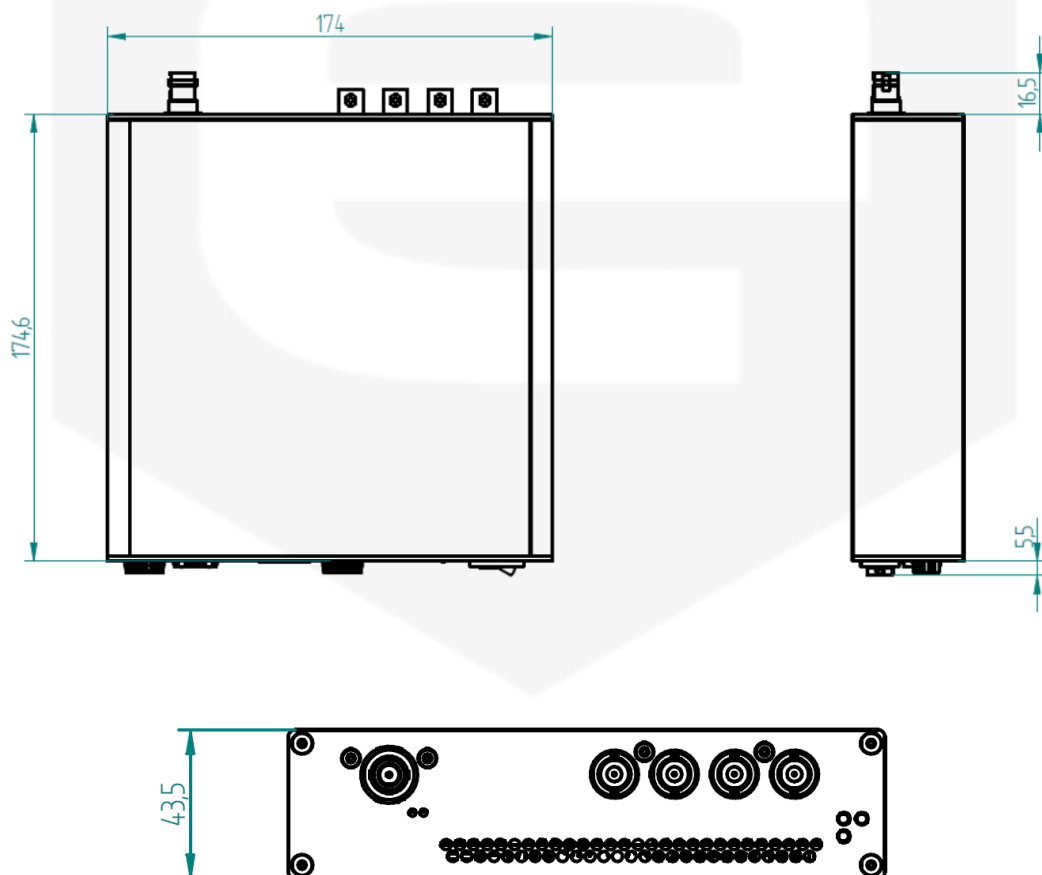

**Figure 18:** TetrAMM mechanical dimensions

## 7. TetrAMM Power Supply

This chapter describes the general characteristics and the main features of the TetrAMM low-noise power supply called PS1112S. This power supply is particularly designed for operation with the ELS Instruments TetrAMM picoammeter.

### 7.1 The PS1112S Linear Power Supply

ELS Instruments PS1112S is a single-output +12 V mixed switching-linear power supply that is designed in order to obtain low-noise operation and high efficiency and it is especially suited for measurement systems where switching power supplies could corrupt measuring noise, accuracy and precision.

The power supply is housed in a robust and compact stainless-steel box that can be placed next to the supplied device in order to reduce cable lengths and minimize consequent possible noise pick-up.

### 7.2 The PS1112S at a Glance

The PS1112S linear power supply and its I/Os are represented in **Figure 19**. The PS1112S is an isolated power supply, with a 3-pole output connector, specifically designed to supply low current and precision instrumentation.

The AC Power Line input is placed on the left side of the box while the output connectors on the right side; LED monitor (indicating the presence of the output voltage) is placed on the front side.



**Figure 19:** overall view of a PS1112S power supply

The PS1112S is an isolated power supply, with a 3-pole output connector, specifically designed to supply low current and precision instrumentation.

The AC Power Line input is placed on the left side of the box while the output connectors on the right side; LED monitor (indicating the presence of the output voltage) is placed on the front side.

The PS1112S has a standard +12 V output voltage, as indicated in the following table:

	Positive Output Voltage
PS1112S	12 V @ 1.2 A

## 7.3 Technical Data

The PS1112S power supply has an output voltage accuracy of  $\pm 3\%$  - i.e. from 11.64 V to 12.36 V.

Maximum peak-to-peak voltage noise measured at the device output terminals is rated at 4 mV. This value is measured over a 1 MHz bandwidth using a LeCroy MSO 44MXs-B, 400MHz, 5GS/s with AC Coupling at full load. A typical output waveform used to estimate the peak-to-peak noise value is shown in **Figure 20**.

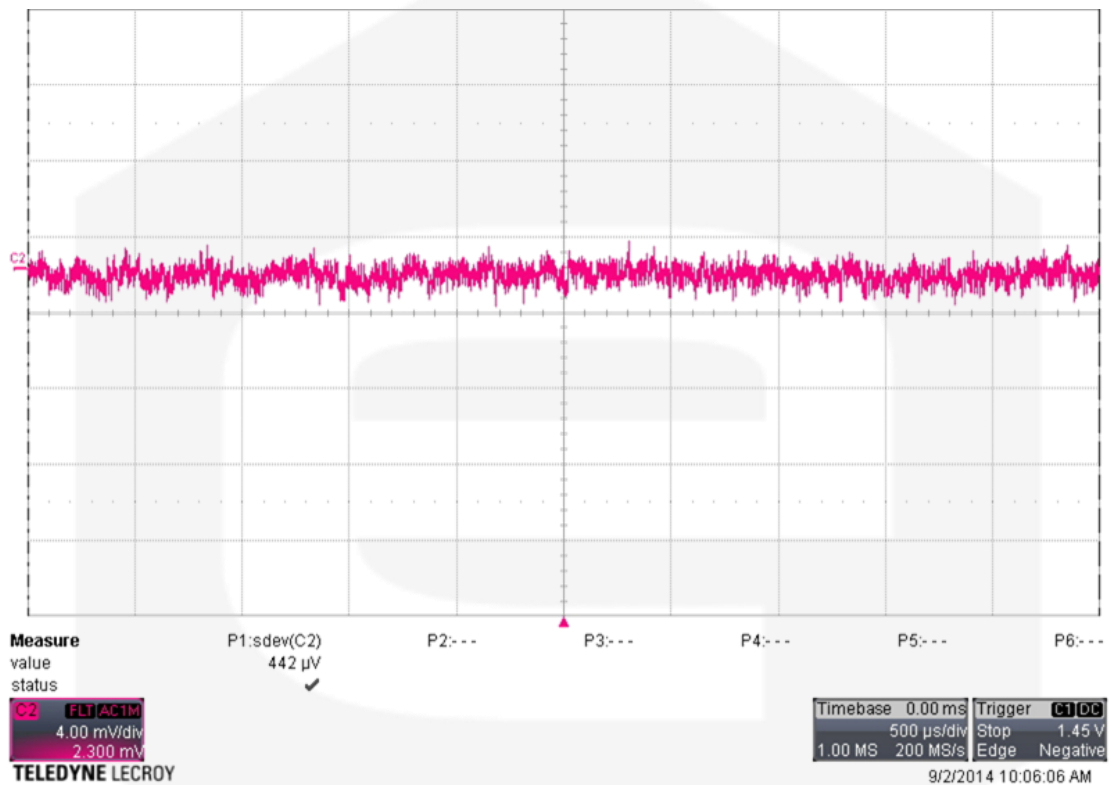

**Figure 20:** typical output noise - AC coupling

The PS1112S outputs are floating respect Earth up to 500V, protected against short-circuit and from over-voltage.

## 7.4 I/O Connectors

This chapter describes the I/O connectors and switches, their corresponding pinout and their functionality.

### 7.4.1 AC Line Input Connector

The AC Line Input connector is in a standard IEC Male Socket as shown in **Figure 21**.

The PS1112S power supply is designed for universal AC input voltage range since it can operate with voltage from 90V to 260V and input frequency from 47 to 63 Hz. Under the value of 115V AC Mains input the Power Supply is subject to current (i.e. power) de-rating.



**Figure 21:** AC Line input connector

### 7.4.2 Output

Output DC voltage is made available through a 3-pole connector with a screw locking. The pin-out of the connector (frontal view) is shown in **Figure 22**.



**Figure 22:** Output DC Connector (TE 1838839-1)

The output connector has the following pin-out:

Pin #	PS112S
1	+12V
3	nc
4	GND

In the same package of the power supply PS112S there is also a mating un-terminated cable that can be terminated with the desired connector.

### 7.4.3 Status LED

On a lateral side of the power supply, two LEDs turn off whenever the +12V is not correctly regulated on the output cable.

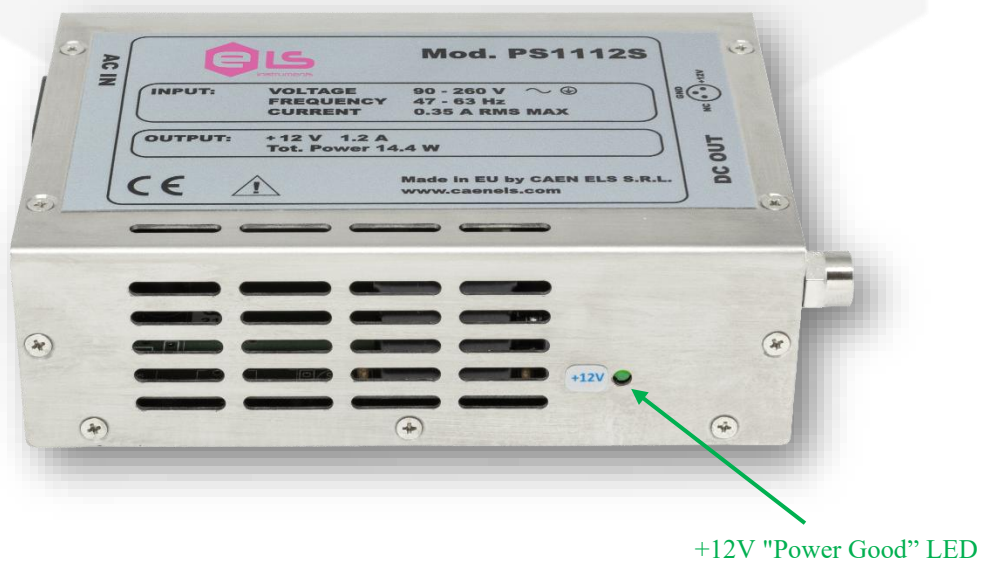

**Figure 23:** LED indicators for output voltage

### 7.4.4 Mechanical Fixing

On the bottom side of the PS1112S four threaded M3×4mm holes can be used for fixing the power supply. These are indicated in the following **Figure 24**.

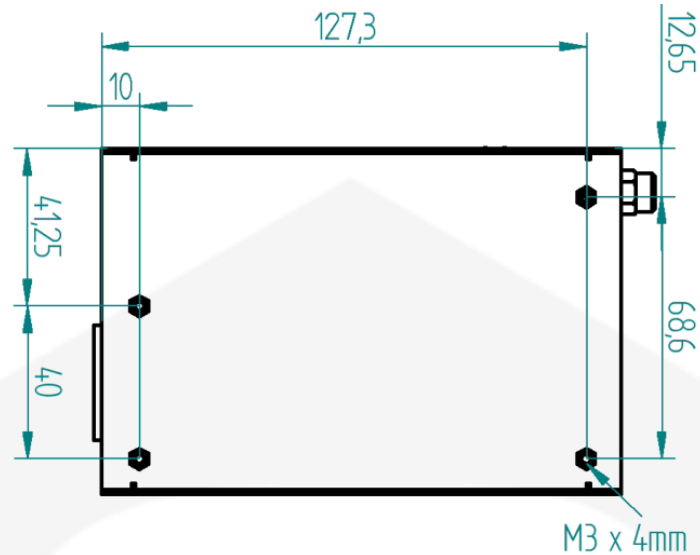

**Figure 24:** Threaded holes position on the PS1112S bottom

### 7.5 Mounting position

PS1112S shall **NOT be mounted** in the two following positions:

- bottom side of the box fixed to the ceiling (**Figure 25**);
- lateral side of the box that present ten ventilation holes faced to the top (**Figure 26**).

The RECOMMENDED mounting positions for increasing the heat dissipation and increasing reliability and life-time are:

- bottom side of the box fixed to the floor;
- lateral side of the box that present twenty ventilation holes faced to the top.



**Figure 25:** Ceiling mounting NOT allowed

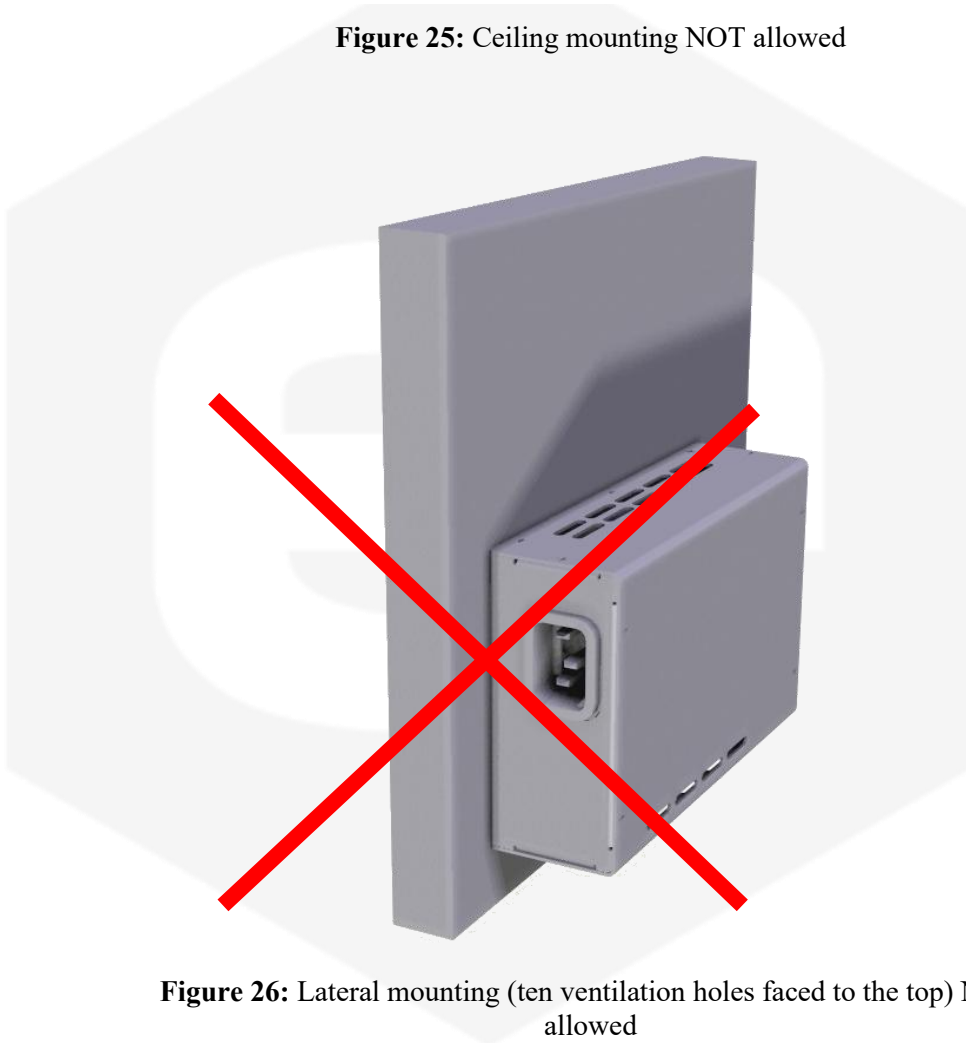

**Figure 26:** Lateral mounting (ten ventilation holes faced to the top) NOT allowed

## 7.6 Technical Specifications

Technical Specifications for the PS1112S linear power supplies are presented in the following table:

Technical Specifications	PS1112S
Output Voltage ( $\pm 3\%$ )	+12 V
Maximum Output Power	14.4 W
Maximum Output Current	+12V @ 1.2 A
Output Ripple + Noise	0.003 % <sub>RMS</sub> @ DC-1MHz 0.025 % <sub>P-P</sub> @ DC-1MHz
AC Line Voltage Input	90 – 260 V <sub>AC</sub>
AC Line Frequency	47 - 63 Hz
Input to Output Isolation	3 kV
Output to Earth-Case Isolation	500 V
Hold-up time	16 ms typ. at 115 V <sub>AC</sub>
Cooling	Natural convection
Dimensions	136.4 × 41 × 90.7 mm
Weight	600 g
Y-Cable length (CT-I and CT-V)	3 m
Indicators	1 LED (Power Good)
Protections	Output short-circuit Output over-voltage
Operating Temperature Range	0 °C – 50 °C

## 8. 19"-2U Mounting Crate - *optional*

### 8.1 Description

A 19"2U mounting crate is also available in order to mount up to two TetrAMM devices, together with their respective PS1112S power supplies in a standard cabinet. This unit is also compatible with the PreDAC devices and the EnBOX devices by ELS Instruments.

A single 19"-2U crate, metal and plastic-made, can house up to two TetrAMM devices as shown in **Figure 27** and **Figure 28**. The devices can be mounted with the front-end and bias connectors on the front and the communication/interlock/etc. on the rear side or vice-versa.

The TetrAMM housed in the box are not in direct contact with metal part and so the front-ends and the bias voltage can be floating respect to the external case (i.e. Protective Earth PE) up to  $\pm 30$  V. This allows the TetrAMM, for example, to work as a bias device for silicon photodiodes in order to characterize their behavior.



**Figure 27:** 19"-2U crate front view



**Figure 28:** 19"-2U crate rear view

The connections of the PS1112S to the AC mains and from the PS1112S to the TetrAMM unit needs to be performed as shown in **Figure 29**:



**Figure 29:** power supply connections

The ordering code for these 19"-2U crates is hereafter shown (please indicate the ordering code and its description at the time of order):

Ordering Code	Description
<b>MEC--BEI0007</b>	19"-2U Mounting Tray for 2 TetrAMM, PreDAC or EnBox Devices

The mounting crate/tray has a total depth of approximately 175 mm, excluding the TetrAMM connectors (other dimensions are standard 19" width and 2U height). The total weight of the 19"-2U mounting crate filled with both TetrAMMs and their respective power supplies is of 4,850 kg (approximately 10,7 lbs).

## 9. Appendix

### 9.1 List of the Error Codes

The TetrAMM unit replies with a Not AcKnowledge (“NAK”) if the received command is not correct or it is not accepted. This “NAK” reply is followed by a two digit “error code” field, which indicates the error cause and/or type. The list of the possible error codes is hereafter presented:

<b>Error Code</b>	<b>Error name</b>	<b>Error Description</b>
<b>00</b>	<b>Invalid command</b>	<i>Command field is not valid; the list of valid commands is shown in the Command Table Summary section</i>
<b>10</b>	<b>Wrong ACQ acquisition parameter</b>	<i>Given parameter is not allowed ACQ setting (see ACQ Command)</i>
<b>11</b>	<b>Wrong GET acquisition parameter</b>	<i>Given parameter is not allowed GET setting (see GET Command)</i>
<b>12</b>	<b>Wrong NAQ acquisition parameter</b>	<i>Given parameter is out of allowed values for NAQ setting (see NAQ Command)</i>
<b>13</b>	<b>Wrong TRG acquisition parameter</b>	<i>Given parameter is out of allowed values for trigger setting (see TRG Command)</i>
<b>15</b>	<b>Wrong FASTNAQ acquisition parameter</b>	<i>Given parameter is out of allowed values for FASTNAQ setting (see FASTNAQ Command)</i>
<b>16</b>	<b>Wrong NTRG configuration parameter</b>	<i>Wrong parameter value for NTRG Command</i>
<b>17</b>	<b>Wrong TRGPOL parameter</b>	<i>TRGPOL has been set neither POS or NEG</i>
<b>20</b>	<b>Wrong number of channels parameter</b>	<i>Given parameter is out of allowed values for channels setting (see CHN Command)</i>
<b>21</b>	<b>Wrong ASCII parameter</b>	<i>Given parameter is not allowed ASCII setting (see ASCII Command)</i>
<b>22</b>	<b>Wrong range parameter</b>	<i>Given parameter is out of allowed values for range setting (see RNG Command)</i>

23	<b>Wrong user correction parameter</b>	<i>Given parameter is not allowed user correction setting (see USRCORR Command)</i>
24	<b>Wrong number of samples parameter</b>	<i>Given parameter is not allowed number of samples setting (see NRSAMP Command)</i>
25	<b>Wrong status parameter</b>	<i>Given parameter is not allowed for user correction setting (see STATUS Command)</i>
26	<b>Wrong interlock parameter</b>	<i>Given parameter is not allowed for interlock setting (see INTERLOCK Command)</i>
27	<b>Wrong High Voltage parameter</b>	<i>Given parameter is not allowed for High voltage setting (see HVS Command)</i>
30	<b>HV Fault</b>	<i>Bias Voltage module cannot be turned ON, because a faults condition occurs. Solve the fault cause and reset the status register (see STATUS Command)</i>
40	<b>Wrong PKTSIZE parameter</b>	<i>Given parameter is not allowed</i>
54	<b>Wrong voltage value</b>	<i>Given voltage value not permitted (i.e. exceeds the limits, see HVS Command)</i>
96	<b>Wrong Device ID</b>	<i>Device ID error (see DEVID Command)</i>